

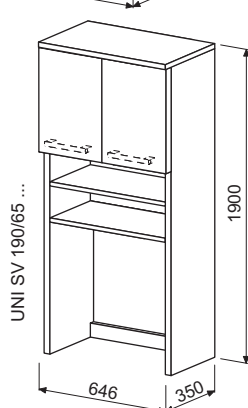

<p><b>!</b> Před montáží zkontrolujte nosnost zdi. Před montáží zkontrolujte, zda je použitý upevňovací materiál vhodný pro daný typ zdi. V případě potřeby použijte jiný upevňovací materiál.</p>	<p>Vor der Montage die Tragfähigkeit der Wand prüfen. Vor der Montage prüfen, ob das mitgelieferte Befestigungsmaterial für den Wandtyp geeignet ist. Das Befestigungsmaterial bei Bedarf austauschen.</p>	<p>Before installation, check the bearing capacity of the wall. Before installation, check whether the fastening material supplied is suitable for the wall type. Use a different type of fastening material if necessary.</p>
--	--	--

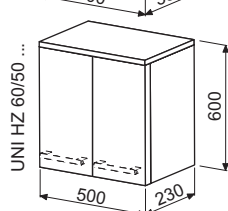

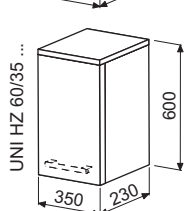
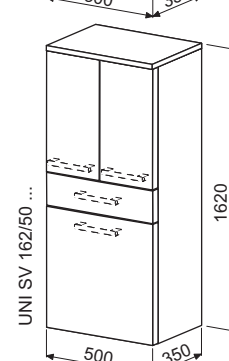
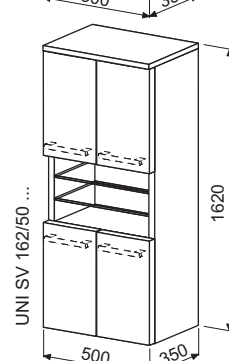
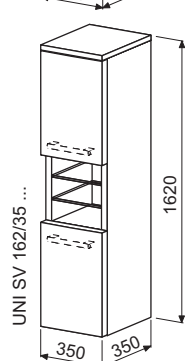
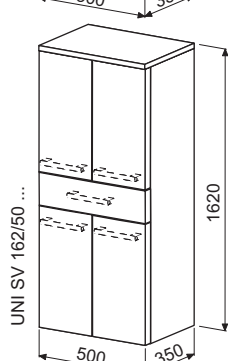
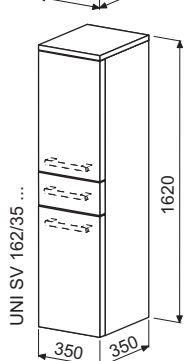
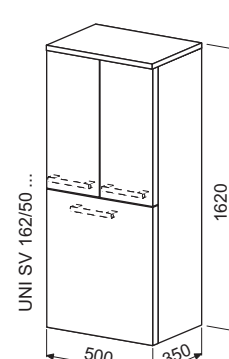
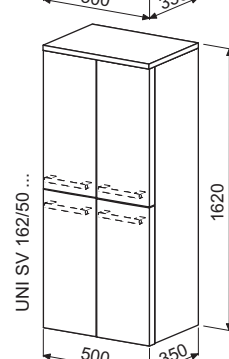
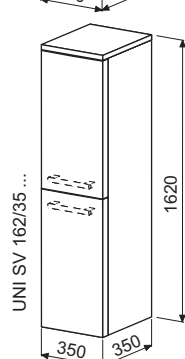
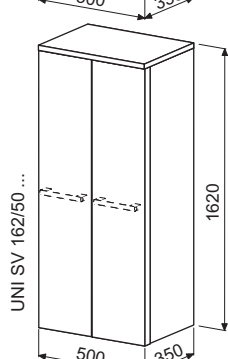
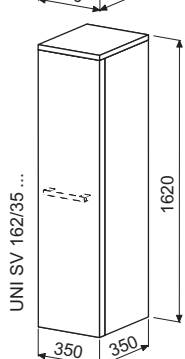
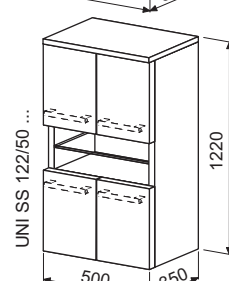
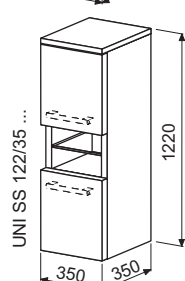
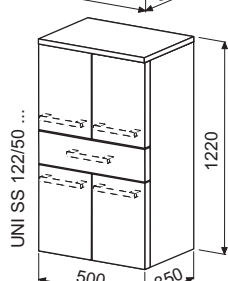
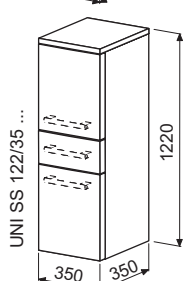
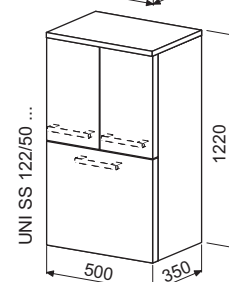
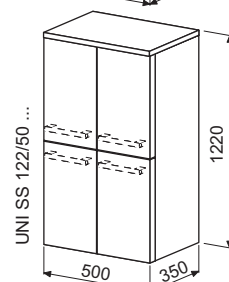
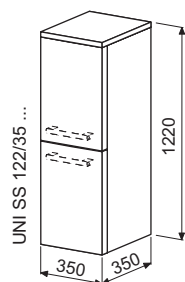
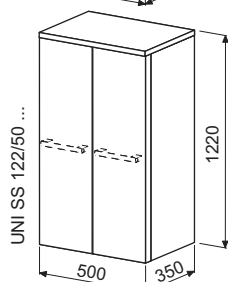
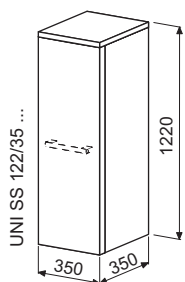
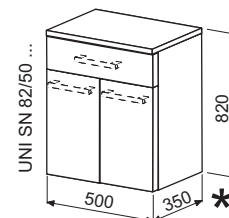
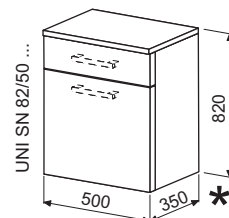
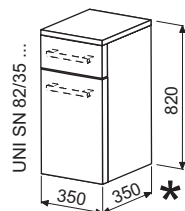
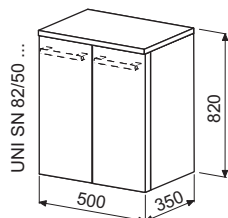
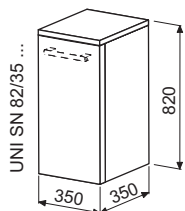

1\*

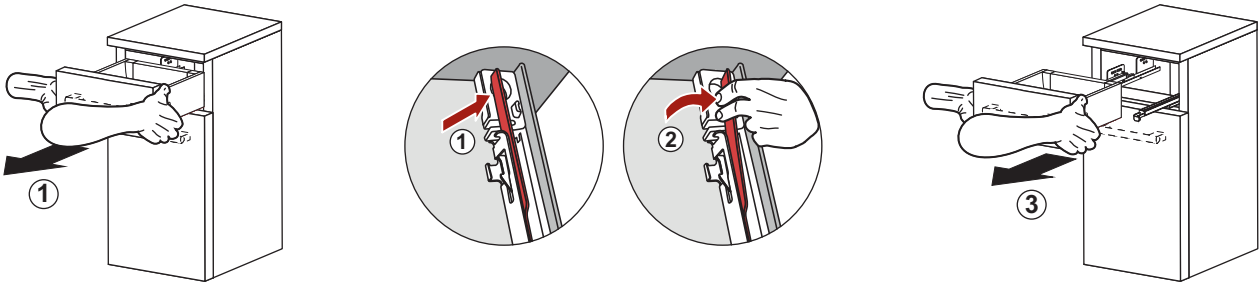

1

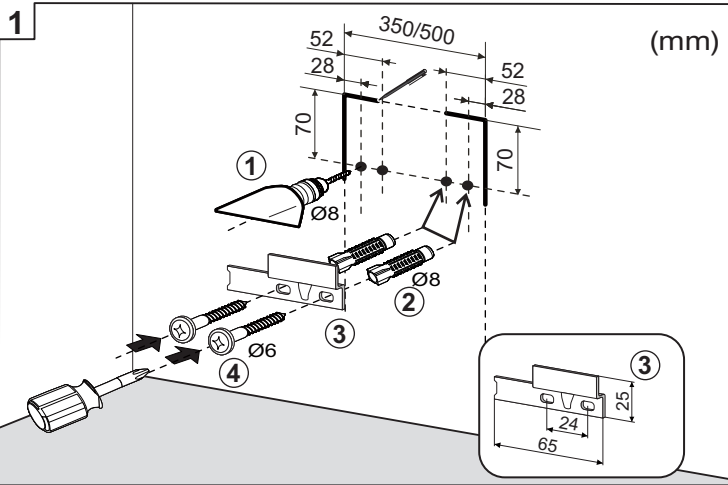

2

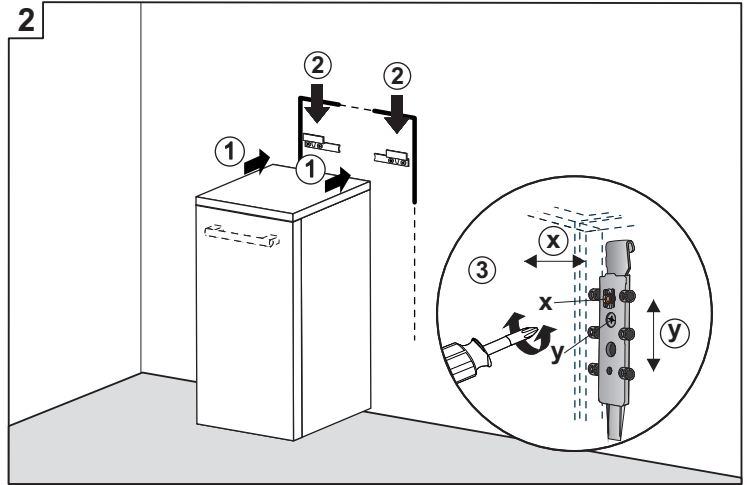

3\*

