

INTEDOOR[®] | BATHROOM FURNITURE

2023/05



 **Family
Business**
Czech Republic

www.intedoor.cz/en

Family business

Production of bathroom furniture



INTEDOOR®



INTEDOOR s.r.o.

We are a modern, technologically advanced company based in Czech Republic, in Cvikov, 25 km from the border with Germany. Family business with tradition and specialization in the production of bathroom furniture since 1999.

Thanks to quality, reliability and design, Intedoor belongs among the foremost European producers in this field. Production runs on the high-tech production devices, mainly of German origin, in two production plants. Intedoor is a supplier for several lead European companies - see references.

Lubomír Langer
director

INTEDOOR offers you

Fast and reliable on-time deliveries of desired quantity and assortment.

Modern design.

Wide range of woods and painted colors in high-gloss and matt finish.

Unique software for configuration, production and supplies of the tailor-made furniture.

Professional communication with partners.

Quality guarantee

Certified materials from lead European producers.

Certified production process - ISO, LQS, TÜV electric equipment and lights.

Edge-banding with PUR glue, enhanced protection against humidity.

Environmental protection by utilization of BAT technologies.

See page 5 for more information.

Partners and references

Sanitas Troesch (Switzerland)

Galvano (Netherlands)

Brødrene Dahl (Norway)

Optima Bad (Norway)

Fliesendorf (Austria)

Veto (Slovenia)

Eltron (Slovenia)

Bouygues Construction (France)

Jointrade (Malta)

Ísleifur Jónsson (Iceland)

SME Sales (Ireland)

SIKO Koupelny a kuchyně

Laufen

Richter Frenzel

Gienger

PTÁČEK – velkoobchod, a.s.

MARO s.r.o.

Saint-Gobain Building Distribution

and many other happy business partners in Germany, Czech and Slovak Republic.

Content

Technical information	04
CSR GREEN DEAL ESG	05
LETTY	06
TARA	24
KRIOS	36
OXO MULTI	44
OXO ALU / stand-alone ALU rack-shelves	66
BRAVE	68
How to order	76
Colors	78
Handles	79
STORM NEW	80
GUEST	86
BOX	88
DESK NEW	96 100
IDEAL	102
FORTY	108
UNI / universal side cabinets	118
Mirrors and mirror cabinets suitable for all series	136
Lamps for mirrors and mirror cabinets	138
Accessories	
Organization tray for drawers	
Furniture legs and consoles	
Washbasin faucets, drains and siphons	
Electric equipment for drawers and side cabinets	152
Contact	

Technical information

A) Furniture

Front panels - materials of thickness 18 - 22 mm

- Painted finish: MDF + 1-2 mm ABS edge, spraying by PUR (polyurethane) colors in a high gloss or matt finish, hardened by UV radiation.
- Wood-color finish: MFC 18 mm + 1-2 mm ABS edge in the same color.

Corpuses - MFC 12 – 32 mm

- Painted finish: MDF + 1-2 mm ABS edge, spraying by PUR (polyurethane) colors in a high gloss or matt finish, hardened by UV radiation.
- Wood-color finish: MFC 12 - 32 mm + 1-2 mm ABS edge in the same color and structure.

Painting PUR colors are water-resistant, abrasion-resistant and resistant to the mechanical damage.

Matt surfaces come with an anti fingerprint protection. Antibacterial properties of surfaces.

Wood-colors and ABS edges

Melamine-faced chipboard materials are always covered with an ABS edge 0,5 - 2 mm, glued on by PUR adhesives (Jowat). PUR adhesive is suitable for wet environments and it's distinguished by its high water-resistance and thermal stability.

B) Fittings (hinges, drawers)

- Hinges (Hettich, Blum, Strong, Grass) are always fitted with soft-close.
 - Drawers (Hettich, Blum, Strong) are always fitted with a soft-close system too, or Push-to-Open version without handles (InnoTech Atira).
- Drawers are available in several depths (27 - 45 cm), so the cabinets offer maximum storage space. They are also available with 3 different heights and you can order an organizer for all drawer versions.

C) Washbasins

- Ceramic.
- When planning a bathroom, it is necessary to take into account the permitted tolerance in size - 5 to + 15 mm.

D) Lighting and electric equipment

- Wide range of LED lighting, either individual, or integrated inside the mirrors cabinets, or mirror doors.
 - El. socket + switch Berker, can be chosen in black, or white color.
- All with the protection IP44, which allows a safe installation in accordance with the national regulations. TÜV certified.

E) Mirror glass

- Float 3-5 mm (Saint Gobain) with protection against blinding.
- Double-sided mirror doors 6 mm (Saint Gobain).

F) Handles - made of metal and available in chrome finish throughout the whole assortment.

The entire manufacturing process runs on CNC machines.

Computer-controlled systems guarantee an excellent edge-processing, drilling, milling, rigidity and rectangularity of the furniture.

The cabinets are always supplied fully assembled and ready for installation.

Everything carefully packed inside the 5-layer carton boxes, including corner-protectors made of PVC or polystyrene and stretch foil. The package also contains the installation and maintenance instructions.

Protection of copyright and intellectual property

Print materials and website content of company Intedoor spol. s r.o. (texts, photographs, pictures, logos, catalogues and others) are protected by the copyright law and may not be modified, copied, reproduced, distributed or otherwise used for any purpose without the prior written permission of Intedoor spol. s r.o.

The manufacturer reserves the right to make changes in prices or technical parameters without a prior notice. Color renderings are limited by printing technology and might not be accurate. We are not liable for any printing errors.

CSR GREEN DEAL ESG

Intedoor has been responding to the needs of today's world and committed itself to the social responsibility and sustainable development.

Intedoor has been successfully certified in this area by a renowned foreign auditor, EcoVadis, and awarded a silver medal.

We have thus become one of the few European companies with this certification.

We are proud to announce that in terms of environmental sustainability, Intedoor enters 2022 almost without the influence of harmful or chemical substances and hazardous waste from our activities, thanks to completing the implementation of changes in its technological and production processes back in 2021.

We have also completely eliminated emitting VOCs into the atmosphere and created conditions for a consequent reduction in heat and electricity consumption.

In January 2022, we maintained the ISO 14001 certification and the PEFC certificate.

As a family business, we are starting our 23rd year of operation, including the third generation involved in the company's activities. The sustainability of the company's development is bound with the continuous improvement of the social environment, caring for safety and health protection at work and work team satisfaction.

Intedoor is fully transparent to employees, the community, government agencies and business partners and we have set future goals in the field of environmental protection to ensure sustainable development and increase the level of our social responsibility.

For more information, see Intedoor's CSR report at www.intedoor.cz/en/about-us/company.

The catalogue only shows a part of the manufactured assortment, supplied directly by Intedoor and does not contain the OEM assortment we produce for large customers according to their design requirements.



LETTY
NELLY





LETTY

Bathroom furniture **LETTY** comes with ceramic washbasins in sizes 61, 71, 81, 91, 101 and 121 cm.

Depth of the washbasins is 46 cm.

Bathroom furniture **LETTY MINI**, designated for smaller bathrooms, offers washbasins in sizes 51, 61, 71 and 81 cm.

Depth of the washbasins is only 39 cm - see page 15.

Bathroom furniture **LETTY DESK** uses counter-top washbasins in sizes 50, 60 and 80 cm, with depth of 42 cm.

Cabinets are equipped with modern soft-close drawer system **StrongMax**.

Accessories - starting at page 138.

 Detail - LETTY handle



 The cabinets are always supplied fully assembled and ready for installation.

How to order a washbasin cabinet and a side cabinet LETTY

- 1) Choose a cabinet.
- 2) Choose a color.
- 3) Follow the same steps to order a side cabinet.
- 4) Accessories like faucets, siphons, different organization trays and others, you can find from page 138.
- 5) Mirrors, mirror cabinets and lamps you can choose starting from page 118.

E.g.	Furniture code LE 100 2Z	Color A3136
------	------------------------------------	-----------------------

E.g.	Furniture code LE SV 35 2D P	Color A3136
------	--	-----------------------

L = hinges on the left side
P = hinges on the right side

1- 4D = number of doors (side cabinets)
1- 4Z = number of drawers
HZ = upper cabinet
SN = low cabinet
SV = high cabinet

Plumbing installation heights

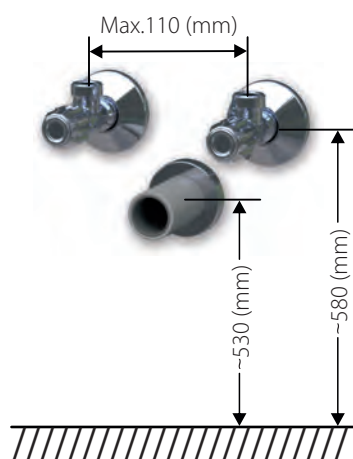

➤ Recommended saving siphon OXO D US660, with adjustable height and depth, for furniture washbasins, to be found on page 149.



Wood colors

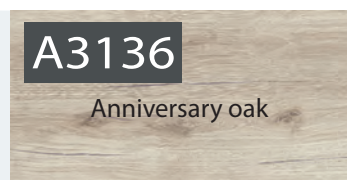

➤ Melamine faced and painted boards have excellent antibacterial properties with a capability of significant reduction of bacteria and germs on the furniture surface within 24 hours.

Painted colors

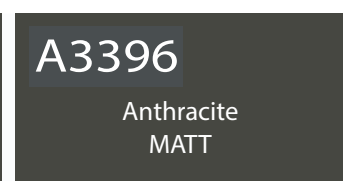
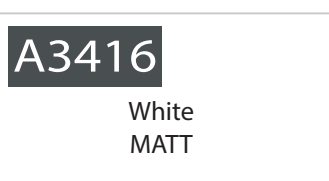

Wood-colors have distinctive wood-structures and painted colors are lacquered in hi-gloss or deep matt finish. Matt painted colors have an anti-fingerprint protection.



LETTY

Versions: with 1, 2 and 3 drawers



LETTY cabinets with ceramic washbasin

Height of the washbasins is 15 mm.

LETTY cabinet with washbasin w. 610 mm, 1 drawer

Dimensions incl. washbasin (W x D x H): 610 x 460 x 365 mm

LE 60 1Z



LETTY cabinet with washbasin w. 710 mm, 1 drawer

Dimensions incl. washbasin (W x D x H): 710 x 460 x 365 mm

LE 70 1Z



LETTY cabinet with washbasin w. 610 mm, 2 drawers

Dimensions incl. washbasin (W x D x H): 610 x 460 x 595 mm

LE 60 2Z



LETTY cabinet with washbasin w. 710 mm, 2 drawers

Dimensions incl. washbasin (W x D x H): 710 x 460 x 595mm

LE 70 2Z



LETTY cabinet with washbasin w. 610 mm, 3 drawers

Dimensions incl. washbasin (W x D x H): 610 x 460 x 705 mm

LE 60 3Z



LETTY cabinet with washbasin w. 710 mm, 3 drawers

Dimensions incl. washbasin (W x D x H): 710 x 460 x 705 mm

LE 70 3Z



LETTY cabinets with ceramic washbasin

Height of the washbasins is 15 mm.

LETTY cabinet with washbasin w. 810 mm, 1 drawer

Dimensions incl. washbasin (W x D x H): 810 x 460 x 365 mm

LE 80 1Z



LETTY cabinet with washbasin w. 910 mm, 1 drawer

Dimensions incl. washbasin (W x D x H): 910 x 460 x 365 mm

LE 90 1Z



LETTY cabinet with washbasin w. 810 mm, 2 drawers

Dimensions incl. washbasin (W x D x H): 810 x 460 x 595 mm

LE 80 2Z



LETTY cabinet with washbasin w. 910 mm, 2 drawers

Dimensions incl. washbasin (W x D x H): 910 x 460 x 595mm

LE 90 2Z



LETTY cabinet with washbasin w. 810 mm, 3 drawers

Dimensions incl. washbasin (W x D x H): 810 x 460 x 705 mm

LE 80 3Z



LETTY cabinet with washbasin w. 910 mm, 3 drawers

Dimensions incl. washbasin (W x D x H): 910 x 460 x 705 mm

LE 90 3Z



LETTY cabinets with ceramic washbasin

Height of the washbasins is 15 mm.

LETTY cabinet with washbasin w. 1010 mm, 1 drawer

Dimensions incl. washbasin (W x D x H): 1010 x 460 x 365 mm

LE 100 1Z



LETTY cabinet with washbasin w. 1210 mm, 1 drawer

Dimensions incl. washbasin (W x D x H): 1210 x 460 x 365 mm

LE 120 1Z



LETTY cabinet with washbasin w. 1010 mm, 2 drawers

Dimensions incl. washbasin (W x D x H): 1010 x 460 x 595 mm

LE 100 2Z



LETTY cabinet with washbasin w. 1210 mm, 2 drawers

Dimensions incl. washbasin (W x D x H): 1210 x 460 x 595mm

LE 120 2Z



LETTY cabinet with washbasin w. 1010 mm, 3 drawers

Dimensions incl. washbasin (W x D x H): 1010 x 460 x 705 mm

LE 100 3Z



LETTY cabinet with washbasin w. 1210 mm, 3 drawers

Dimensions incl. washbasin (W x D x H): 1210 x 460 x 705 mm

LE 120 3Z



LETTY cabinets with ceramic washbasin

Height of the washbasins is 15 mm.

LETTY cabinet with double-washbasin w. 1210 mm, 1 drawer

Dimensions incl. washbasin (W x D x H): 1210 x 460 x 365 mm

LE 120D 1Z



LETTY cabinet with double-washbasin w. 1210 mm, 2 drawers

Dimensions incl. washbasin (W x D x H): 1210 x 460 x 595mm

LE 120D 2Z



LETTY cabinet with double-washbasin w. 1210 mm, 3 drawers

Dimensions incl. washbasin (W x D x H): 1210 x 460 x 705 mm

LE 120D 3Z



LETTY MINI cabinets with ceramic washbasin

Height of the washbasins is 15 mm.

 Bathroom furniture LETTY MINI is designed for smaller bathrooms.

LETTY MINI cabinet with washbasin w. 510 mm, 1 drawer
Dimensions incl. washbasin (W x D x H): 510 x 395 x 365 mm
LE MINI 50 1Z



LETTY MINI cabinet with washbasin w. 610 mm, 1 drawer
Dimensions incl. washbasin (W x D x H): 610 x 395 x 365 mm
LE MINI 60 1Z



LETTY MINI cabinet with washbasin w. 510 mm, 2 drawers
Dimensions incl. washbasin (W x D x H): 510 x 395 x 595 mm
LE MINI 50 2Z



LETTY MINI cabinet with washbasin w. 610 mm, 2 drawers
Dimensions incl. washbasin (W x D x H): 610 x 395 x 595 mm
LE MINI 60 2Z



LETTY MINI cabinet with washbasin w. 510 mm, 3 drawers
Dimensions incl. washbasin (W x D x H): 510 x 395 x 705 mm
LE MINI 50 3Z



LETTY MINI cabinet with washbasin w. 610 mm, 3 drawers
Dimensions incl. washbasin (W x D x H): 610 x 395 x 705 mm
LE MINI 60 3Z



 Depth of the washbasins is only 39,5cm.

LETTY MINI cabinets with ceramic washbasin

Height of the washbasins is 15 mm.

 Bathroom furniture LETTY MINI is designed for smaller bathrooms.

LETTY MINI cabinet with washbasin w. 710 mm, 1 drawer
Dimensions incl. washbasin (W x D x H): 710 x 395 x 365 mm
LE MINI 70 1Z



LETTY MINI cabinet with washbasin w. 810 mm, 1 drawer
Dimensions incl. washbasin (W x D x H): 810 x 395 x 365 mm
LE MINI 80 1Z



LETTY MINI cabinet with washbasin w. 710 mm, 2 drawers
Dimensions incl. washbasin (W x D x H): 710 x 395 x 595 mm
LE MINI 70 2Z



LETTY MINI cabinet with washbasin w. 810 mm, 2 drawers
Dimensions incl. washbasin (W x D x H): 810 x 395 x 595 mm
LE MINI 80 2Z



LETTY MINI cabinet with washbasin w. 710 mm, 3 drawers
Dimensions incl. washbasin (W x D x H): 710 x 395 x 705 mm
LE MINI 70 3Z



LETTY MINI cabinet with washbasin w. 810 mm, 3 drawers
Dimensions incl. washbasin (W x D x H): 810 x 395 x 705 mm
LE MINI 80 3Z



 Depth of the washbasins is only 39,5cm.

LETTY cabinets with ceramic washbasin



The new **StrongMax** soft-close drawer system allows a maximum use of the drawer space. It's distinguished by its thinner sides and quiet and flawless running. The dark surface is pleasant to the touch and underlines the purity of the furniture design.





LETTY DESK

Versions: with 1 or 2 drawers



LETTY DESK cabinets with ceramic counter-top washbasins

Height of the washbasins is 130 mm.

LETTY cabinet w. 600 mm with counter-top W/B, 1 drawer

Dimensions incl. washbasin (W x D x H): 600 x 460 x 516 mm

LE DESK 60 1Z



LETTY cabinet w. 600 mm with counter-top W/B, 2 drawers

Dimensions incl. washbasin (W x D x H): 600 x 460 x 746 mm

LE DESK 60 2Z



 Counter-top washbasins (W x D x H) 500 x 420 x 130 mm

LETTY cabinet w. 700 mm with counter-top W/B, 1 drawer

Dimensions incl. washbasin (W x D x H): 700 x 460 x 516 mm

LE DESK 70 1Z



LETTY cabinet w. 700 mm with counter-top W/B, 2 drawers

Dimensions incl. washbasin (W x D x H): 700 x 460 x 746 mm

LE DESK 70 2Z



 Counter-top washbasins (W x D x H) 500 x 420 x 130 mm

LETTY DESK cabinets with ceramic counter-top washbasins

Height of the washbasins is 130 mm.

LETTY cabinet w. 800 mm with counter-top W/B, 1 drawer
Dimensions incl. washbasin (W x D x H): 800 x 460 x 516 mm
LE DESK 80 1Z



LETTY cabinet w. 800 mm with counter-top W/B, 2 drawers
Dimensions incl. washbasin (W x D x H): 800 x 460 x 746 mm
LE DESK 80 2Z



 Counter-top washbasins (W x D x H) 600 x 420 x 130 mm

LETTY cabinet w. 900 mm with counter-top W/B, 1 drawer
Dimensions incl. washbasin (W x D x H): 900 x 460 x 516 mm
LE DESK 90 1Z



LETTY cabinet w. 900 mm with counter-top W/B, 2 drawers
Dimensions incl. washbasin (W x D x H): 900 x 460 x 746 mm
LE DESK 90 2Z



 Counter-top washbasins (W x D x H) 600 x 420 x 130 mm

LETTY DESK cabinets with ceramic counter-top washbasins

Height of the washbasins is 130 mm.

LETTY cabinet w. 1000 mm with counter-top W/B, 1 drawer

Dimensions incl. washbasin (W x D x H): 1000 x 460 x 516 mm

LE DESK 100 1Z



LETTY cabinet w. 1000 mm with counter-top W/B, 2 drawers

Dimensions incl. washbasin (W x D x H): 1000 x 460 x 746 mm

LE DESK 100 2Z



 Counter-top washbasins (W x D x H) 800 x 420 x 130 mm

LETTY cabinet w. 1200 mm with counter-top W/B, 1 drawer

Dimensions incl. washbasin (W x D x H): 1200 x 460 x 516 mm

LE DESK 120 1Z



LETTY cabinet w. 1200 mm with counter-top W/B, 2 drawers

Dimensions incl. washbasin (W x D x H): 1200 x 460 x 746 mm

LE DESK 120 2Z



 Counter-top washbasins (W x D x H) 800 x 420 x 130 mm

LETTY DESK cabinets with ceramic counter-top washbasins

Height of the washbasins is 130 mm.

LETTY cabinet w. 1200 mm with counter-top W/B, 1 drawer
Dimensions incl. washbasin (W x D x H): 1200 x 460 x 516 mm
LE DESK 120D 1Z



LETTY cabinet w. 1200 mm with counter-top W/B, 2 drawers
Dimensions incl. washbasin (W x D x H): 1200 x 460 x 746 mm
LE DESK 120D 2Z



▶ Water outlets C/C 600 mm

▶ Counter-top washbasins (W x D x H) 500 x 420 x 130 mm

LETTY side cabinets

▶ Adjustable glass-shelves

LETTY high cabinet 50, 4 doors
Dimensions (W x D x H):
500 x 350 x 1600 mm *LE SV 50 4D*



▶ Right - hinges on the right

LETTY high cabinet 35, 2 doors, right
Dimensions (W x D x H):
350 x 350 x 1600 mm *LE SV 35 2D P*



▶ Left - hinges on the left

LETTY high cabinet 35, 2 doors, left
Dimensions (W x D x H):
350 x 350 x 1600 mm *LE SV 35 2D L*



LETTY side cabinets

 Adjustable glass-shelves

LETTY upper cabinet 50, 2 doors
(W x D x H): 500 x 230 x 820 mm
LEHZ 50 2D



LETTY upper cabinet 35, 1 door, right
(W x D x H): 350 x 230 x 820 mm
LEHZ 35 1DP



LETTY upper cabinet 35, 1 door, left
(W x D x H): 350 x 230 x 820 mm
LEHZ 35 1DL



 Right - hinges on the right

 Left - hinges on the left

LETTY high cabinet 35, 2 doors, right, bin
(W x D x H): 350 x 350 x 1600 mm
LESV 35 2DPK

LETTY low cabinet 35, 1 door, right
(W x D x H): 350 x 350 x 820 mm
LESN 35 1DP

LETTY low cabinet 35, 1 door, left
(W x D x H): 350 x 350 x 820 mm
LESN 35 1DL

LETTY high cabinet 35, 2 doors, left, bin
(W x D x H): 350 x 350 x 1600 mm
LESV 35 2DLK



 Right - hinges on the right

 Left - hinges on the left

LETTY low cabinet 35, 1 door, bin
(W x D x H): 350 x 350 x 820 mm
LESN 35 1DK

 Removable laundry bin



 Left - hinges on the left

 Right - hinges on the right



TARA
TABVA





TARA

Bathroom furniture **TARA** comes with ceramic counter-top washbasins in sizes 50 and 60 cm with depth 42 cm. Furniture **TARA** offers a high utility value through its variability and moisture resistance. Upper cover boards are made of a 1,2 cm thick compact board, a high pressure material HPL with black core. The cover board has a structured surface and an opening for a towel and is resistant to water and mechanical damage. The cabinets are equipped with a modern soft-close drawer system **StrongMax**. The storage space can be extended by an open shelf **OALU**, placed under the furniture.

Accessories - see from page 138.

- With versions with the **OALU** open shelf placed under the furniture you will get more airy storage space.
- The constructions of the **OALU** shelves are made of thin-walled aluminium profiles of thickness 2 x 2 cm, in black color. The base-plate inside the open shelf is made of a board in black color.
- To harmonize the whole look of your bathroom, you can also choose mirrors with black frames on page 123, 124, 127 and 128.
- The cabinets are supplied fully assembled and ready for installation.

How to order a washbasin cabinet and a side cabinet TARA

- 1) Choose a cabinet.
- 2) Choose a color.
- 3) Follow the same steps to order a side cabinet.
- 4) Accessories like faucets, siphons, different organization trays and others, you can find from page 138.
- 5) Mirrors, mirror cabinets and lamps you can choose starting from page 118.

E.g.	Furniture code TA OALU 140D 2Z KDP	Color A0016
------	---------------------------------------	----------------

E.g.	Furniture code TA SN 35 K	Color A0016
------	------------------------------	----------------

- L = hinges on the left side
 P = hinges on the right side
 K = laundry bin
 1- 4D = number of doors (side cabinets)
 1- 4Z = number of drawers
 HZ = upper cabinet
 SN = low cabinet
 SV = high cabinet



Plumbing installation heights

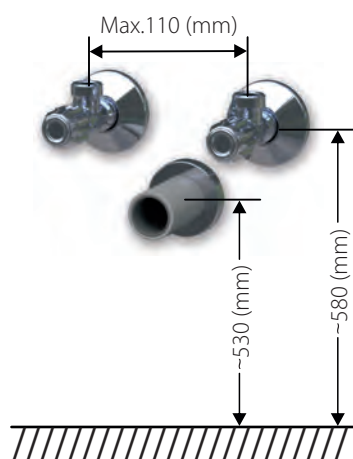

- Recommended saving siphon OXO D US660, with adjustable height and depth, for furniture washbasins, to be found on page 149.



Wood colors

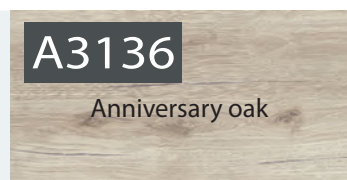

- Melamine faced and painted boards have excellent antibacterial properties with a capability of significant reduction of bacteria and germs on the furniture surface within 24 hours.

Painted colors

A0016 White GLOSSY	A3416 White MATT	A0076 Anthracite GLOSSY	A3396 Anthracite MATT
---------------------------------	-------------------------------	--------------------------------------	------------------------------------

Wood-colors have distinctive wood-structures and painted colors are lacquered in hi-gloss or deep matt finish. Matt painted colors have an anti-fingerprint protection.

TARA cabinets with ceramic counter-top washbasins

Height of the washbasins is 130 mm.

TARA cabinet w. 600 mm with counter-top W/B, 1 drawer
Dimensions incl. washbasin (W x D x H): 680 x 505 x 500 mm
TA 60 1Z KDP



TARA cabinet w. 600 mm with counter-top W/B, 1 drawer
Dimensions incl. washbasin (W x D x H): 680 x 505 x 720 mm
TA OALU 60 1Z KDP



➤ Counter-top washbasins (W x D x H) 500 x 420 x 130 mm

TARA cabinet w. 700 mm with counter-top W/B, 1 drawer
Dimensions incl. washbasin (W x D x H): 780 x 505 x 500 mm
TA 70 1Z KDP



TARA cabinet w. 700 mm with counter-top W/B, 1 drawer
Dimensions incl. washbasin (W x D x H): 780 x 505 x 720 mm
TA OALU 70 1Z KDP



➤ Counter-top washbasins (W x D x H) 600 x 420 x 130 mm

TARA cabinet w. 900 mm with counter-top W/B, 1 drawer
Dimensions incl. washbasin (W x D x H): 980 x 505 x 500 mm
TA 90 1Z KDP



TARA cabinet w. 900 mm with counter-top W/B, 1 drawer
Dimensions incl. washbasin (W x D x H): 980 x 505 x 720 mm
TA OALU 90 1Z KDP



➤ Cover boards with towel holder

TARA cabinets with ceramic counter-top washbasins

Height of the washbasins is 130 mm.

TARA cabinet w. 1200 mm with counter-top W/B, 2 drawers
Dimensions incl. washbasin (W x D x H): 1280 x 505 x 500 mm
TA 120P 2Z KDP



TARA cabinet w. 1200 mm with counter-top W/B, 2 drawers
Dimensions incl. washbasin (W x D x H): 1280 x 505 x 720 mm
TA OALU 120P 2Z KDP



➤ Counter-top washbasins (W x D x H) 500 x 420 x 130 mm

TARA cabinet w. 1200 mm with counter-top W/B, 2 drawers
Dimensions incl. washbasin (W x D x H): 1280 x 505 x 500 mm
TA 120L 2Z KDL



TARA cabinet w. 1200 mm with counter-top W/B, 2 drawers
Dimensions incl. washbasin (W x D x H): 1280 x 505 x 720 mm
TA OALU 120L 2Z KDL



➤ Counter-top washbasins (W x D x H) 500 x 420 x 130 mm

➤ Cover boards with towel holder

TARA cabinets with ceramic counter-top washbasins

Height of the washbasins is 130 mm.

TARA cabinet w. 1200 mm with 2 counter-top W/B's, 2 drawers

Dimensions incl. washbasin (W x D x H): 1280 x 505 x 500 mm

TA 120D 2Z KDP



➤ Water outlets C/C 600 mm

➤ Counter-top washbasins (W x D x H) 500 x 420 x 130 mm

TARA cabinet w. 1200 mm with 2 counter-top W/B's, 2 drawers

Dimensions incl. washbasin (W x D x H): 1280 x 505 x 720 mm

TA OALU 120D 2Z KDP



TARA cabinet w. 1400 mm with 2 counter-top W/B's, 2 drawers

Dimensions incl. washbasin (W x D x H): 1480 x 505 x 500 mm

TA 140D 2Z KDP



➤ Water outlets C/C 700 mm

➤ Counter-top washbasins (W x D x H) 600 x 420 x 130 mm

➤ Cover boards with towel holder

TARA cabinet w. 1400 mm with 2 counter-top W/B's, 2 drawers

Dimensions incl. washbasin (W x D x H): 1480 x 505 x 720 mm

TA OALU 140D 2Z KDP



TARA side cabinet

 Adjustable glass-shelves

TARA high cabinet 50, 4 doors
(W x D x H): 500 x 350 x 1610 mm
TA SV 50 4D



TARA high cabinet 35, 2 doors, right
(W x D x H): 350 x 350 x 1610 mm
TA SV 35 2DP



TARA high cabinet 35, 2 doors, left
(W x D x H): 350 x 350 x 1610 mm
TA SV 35 2DL



 Right - hinges on the right

 Left - hinges on the left

TARA low cabinet 35, 1 door, bin
(W x D x H): 350 x 350 x 810 mm
TA SN 35 K



TARA low cabinet 35, 1 door, right
(W x D x H): 350 x 350 x 810 mm
TA SN 35 1DP



TARA low cabinet 35, 1 door, left
(W x D x H): 350 x 350 x 810 mm
TA SN 35 1DL



 Right - hinges on the right

 Left - hinges on the left

 Removable laundry bin

TARA side cabinets

 Adjustable glass-shelves

TARA high cabinet 50, 4 doors
(W x D x H): 500 x 350 x 1830 mm
TA OALU SV 50 4D



TARA high cabinet 35, 2 doors, right
(W x D x H): 350 x 350 x 1830 mm
TA OALU SV 35 2DP



TARA high cabinet 35, 2 doors, left
(W x D x H): 350 x 350 x 1830 mm
TA OALU SV 35 2DL



TARA low cabinet 35, 1 door, bin
(W x D x H): 350 x 350 x 1030 mm
TA OALU SN 35 K



TARA low cabinet 35, 1 door, right
(W x D x H): 350 x 350 x 1030 mm
TA OALU SN 35 1DP



TARA low cabinet 35, 1 door, left
(W x D x H): 350 x 350 x 1030 mm
TA OALU SN 35 1DL



 Removable laundry bin

 Right - hinges on the right

 Left - hinges on the left

TARA side cabinets

 Adjustable glass-shelves

TARA high cabinet 35, 2 doors, bin, right
(W x D x H): 350 x 350 x 1610 mm
TA SV 35 2D KP



 Right - hinges on the right

 Removable laundry bin

TARA high cabinet 35, 2 doors, bin, left
(W x D x H): 350 x 350 x 1610 mm
TA SV 35 2D KL



 Left - hinges on the left

TARA side cabinets

 Adjustable glass-shelves

TARA high cabinet 35, 2 doors, bin, right
(W x D x H): 350 x 350 x 1830 mm
TA OALU SV 35 2D KP



 Right - hinges on the right

 Removable laundry bin

TARA high cabinet 35, 2 doors, bin, left
(W x D x H): 350 x 350 x 1830 mm
TA OALU SV 35 2D KL



 Left - hinges on the left



TARA



KRIOS
KBIO2





KRIOS

Bathroom furniture **KRIOS** is fitted with ceramic washbasins in sizes 61, 81, 101 and 121 cm. Depth of the washbasins is 46 cm. Subtle ALU construction with inserted drawer cabinet and storage space. Another variant is **KRIOS DESK** bathroom furniture with round ceramic countertop washbasins with 35cm in diameter and height of 12 cm, in glossy white and matt black color. The cover boards are made of a 1,2 cm thick compact board, a high pressure material HPL with black core. The solid cover board with a structured surface is resistant to water and mechanical damage. The cabinets are equipped with a modern soft-close drawer system **StrongMax**.

Accessories - see from page 138.

- The surface of the countertop washbasins is easy to clean in both glossy white and matt black.
- For the side cabinets **UNI**, starting on page 102, please select color **A3416**. We recommend a handleless push-to-open version.
- To harmonize the whole look of your bathroom, you can also choose mirrors with black frames on page 123, 124, 127 and 128.
- The cabinets are supplied fully assembled and ready for installation.

How to order a washbasin cabinet and a side cabinet KRIOS

- 1) Choose a cabinet **KRIOS**.
- 2) *For the side cabinets **UNI**, starting on page **108**, please select the painted color **A3416**.
We recommend to choose the handleless version - Push to open (**PU**).
Optional accessories for side cabinets **UNI** for **KRIOS** series, are shown on page **115**.

E.g.	Furniture code KR 80 1Z W A3416
------	---

E.g.	Furniture code *UNI SV 162/35 2D P	Color A3416	Handle PU
------	--	-----------------------	---------------------



Plumbing installation heights

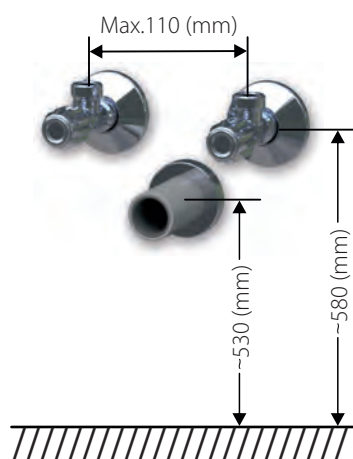

- Recommended saving siphon **OXO D US660**, with adjustable height and depth, for furniture washbasins, to be found on page **149**.



Painted color

A3416

White
MATT

- Melamine faced and painted boards have excellent antibacterial properties with a capability of significant reduction of bacteria and germs on the furniture surface within 24 hours.

White painted color comes in deep matt.
The matt surface has an anti-fingerprint protection.

KRIOS cabinets with ceramic washbasin

Height of the washbasins is 15 mm.

KRIOS cabinet with washbasin w. 610 mm, 1 drawer

Dimensions incl. washbasin (W x D x H): 610 x 460 x 865 mm

KR 60 1Z A3416



KRIOS cabinet with washbasin w. 810 mm, 1 drawer

Dimensions incl. washbasin (W x D x H): 810 x 460 x 865 mm

KR 80 1Z A3416



KRIOS cabinet with washbasin w. 1010 mm, 1 drawer

Dimensions incl. washbasin (W x D x H): 1010 x 460 x 865 mm

KR 100 1Z A3416



 An open-shelf under the washbasin



 A spacious soft-close drawer

KRIOS cabinets with ceramic washbasin

Height of the washbasins is 15 mm.

KRIOS cabinet with washbasin w. 1210 mm, 1 drawer
 Dimensions incl. washbasin (W x D x H): 1210 x 460 x 865 mm
KR 120 1Z A3416



 An open-shelf under the washbasin

KRIOS cabinet with washbasin w. 1210 mm, 1 drawer
 Dimensions incl. washbasin (W x D x H): 1210 x 460 x 865 mm
KR 120D 1Z A3416



 An open-shelf under the washbasin

 Water outlets C/C 595 mm

KRIOS DESK cabinets with ceramic counter-top washbasins

Height of the washbasins is 120 mm.

KRIOS cabinet w. 600 mm with counter-top W/B, 1 drawer
Dimensions incl. washbasin (W x D x H): 600 x 460 x 865 mm
KR DESK 60 1Z W A3416



➤ Counter-top washbasins (W x D x H) 350 x 350 x 120 mm

➤ W = white basin / black cover board

KRIOS cabinet w. 600 mm with counter-top W/B, 1 drawer
Dimensions incl. washbasin (W x D x H): 600 x 460 x 865 mm
KR DESK 60 1Z B A3416



➤ An open-shelf under the washbasin

➤ B = black basin / white-black cover board

KRIOS cabinet w. 800 mm with counter-top W/B, 1 drawer
Dimensions incl. washbasin (W x D x H): 800 x 460 x 865 mm
KR DESK 80 1Z W A3416



➤ Counter-top washbasins (W x D x H) 350 x 350 x 120 mm

KRIOS cabinet w. 800 mm with counter-top W/B, 1 drawer
Dimensions incl. washbasin (W x D x H): 800x 460 x 865 mm
KR DESK 80 1Z B A3416



➤ An open-shelf under the washbasin

KRIOS DESK cabinets with ceramic counter-top washbasins

Height of the washbasins is 120 mm.

KRIOS cabinet w. 1000 mm with counter-top W/B, 1 drawer
Dimensions incl. washbasin (W x D x H) 1000 x 460 x 865 mm
KR DESK 100 1Z W A3416



➤ Counter-top washbasins (W x D x H) 350 x 350 x 120 mm

➤ W = white basin / black cover board

KRIOS cabinet w. 1000 mm with counter-top W/B, 1 drawer
Dimensions incl. washbasin (W x D x H): 1000 x 460 x 865 mm
KR DESK 100 1Z B A3416



➤ An open-shelf under the washbasin

➤ B = black basin / white-black cover board

KRIOS cabinet w. 1200 mm with 2 counter-top W/B's, 1 drawer
Dimensions incl. washbasin (W x D x H): 1200 x 460 x 865 mm
KR DESK 120D 1Z W A3416



➤ Counter-top washbasins (W x D x H) 350 x 350 x 120 mm

➤ Water outlets C/C 600 mm

KRIOS cabinet w. 1200 mm with 2 counter-top W/B's, 1 drawer
Dimensions incl. washbasin (W x D x H): 1200 x 460 x 865 mm
KR DESK 120D 1Z B A3416



➤ An open-shelf under the washbasins



OXO MULTI

OXO MULTI





OXO MULTI

Bathroom furniture **OXO MULTI** with ceramic counter-top washbasins in sizes 50, 60 and 80 cm with depth of 42 cm available in 12 deep matt colors.

Cover board with towel holder and corpus of the furniture is of a massive MULTIPLEX plywood.

This material is highly resistant to scratches and the antibacterial surface has a protection against fingerprints.

Cabinets are equipped with **Hettich InnoTech Atira** drawer system with a popular handleless push-to-open system. For even better functionality, the drawers from width 51 cm are fitted with an opening synchronization.

The storage space can be extended by an **OALU** open-shelf placed under the furniture.

Accessories - see page 138.

- With variants with the **OALU** open shelf placed under the furniture you will get more airy storage space.
- The constructions of the **OALU** shelves are made of thin-walled aluminium profiles of thickness 2 x 2 cm, in silver-grey color. The base-plate inside the open shelf is made of a board in the same color as furniture.
- The cabinets are supplied fully assembled and ready for installation.

How to order a washbasin cabinet and a side cabinet OXO MULTI

- 1) Choose a cabinet.
- 2) Choose a color.
- 3) Follow the same steps to order a side cabinet.
- 4) Accessories like faucets, siphons, different organization trays and others, you can find from page 138.
- 5) Mirrors, mirror cabinets and lamps you can choose starting from page 118.

E.g.	Furniture code OXO MULTI OALU 140D 2Z KDP	Color 0077 AP
------	--	------------------

E.g.	Furniture code OXO MULTI OALU SV 35 2D L	Color 0077 AP
------	---	------------------

L = hinges on the left side
P = hinges on the right side

1- 4D = number of doors (side cabinets)
1- 4Z = number of drawers
HZ = upper cabinet
SN = low cabinet
SV = high cabinet



Plumbing installation heights

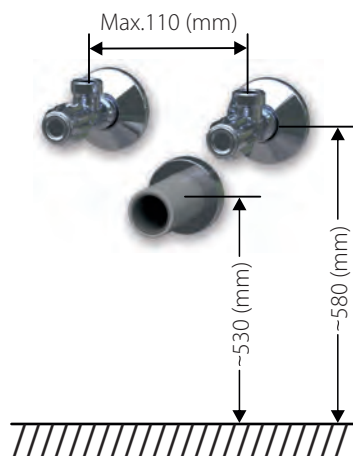

- ▶ Painted boards have excellent antibacterial properties with a capability of significant reduction of bacteria and germs on the furniture surface within 24 hours.
- ▶ Recommended saving siphon OXO D US660, with adjustable height and depth, for furniture washbasins, to be found on page 149.



Colors

0606 AP ARCTIC WHITE MAT 0606 AP	0733 AP HYGIENIC WHITE MAT 0733 AP	2289 AP TORTORA MAT 2289 AP	0693 AP ORCHID MAT 0693 AP	0018 AP DIVARO MAT 0018 AP	2206 AP FANGO MAT 2206 AP
0746 AP HYGIENIC GREY MAT 0746 AP	0753 AP COOL GREY MAT 0753 AP	0075 AP DARK GREY MAT 0075 AP	0755 AP WARM GREY MAT 0755 AP	0077 AP CHARCOAL MAT 0077 AP	0080 AP BLACK MAT 0080 AP

The antibacterial surface in a deep silk mat is pleasant to the touch, has an increased scratch resistance and anti-fingerprint protection.

OXO MULTI cabinets with ceramic counter-top washbasins

Height of the washbasins is 130 mm.

OXO MULTI cabinet w. 600 mm with counter-top W/B, 1 drawer

Dimensions incl. washbasin (W x D x H): 680 x 505 x 520 mm

OXO MULTI 60 1Z KDP



▶ Counter-top washbasins (W x D x H) 500 x 420 x 130 mm

OXO MULTI cabinet w. 700 mm with counter-top W/B, 1 drawer

Dimensions incl. washbasin (W x D x H): 780 x 505 x 520 mm

OXO MULTI 70 1Z KDP



▶ Counter-top washbasins (W x D x H) 600 x 420 x 130 mm

OXO MULTI cabinet w. 900 mm with counter-top W/B, 1 drawer

Dimensions incl. washbasin (W x D x H): 980 x 505 x 520 mm

OXO MULTI 90 1Z KDP



▶ Cover boards with towel holder

OXO MULTI cabinet w. 600 mm with counter-top W/B, 1 drawer

Dimensions incl. washbasin (W x D x H): 680 x 505 x 740 mm

OXO MULTI OALU 60 1Z KDP



OXO MULTI cabinet w. 700 mm with counter-top W/B, 1 drawer

Dimensions incl. washbasin (W x D x H): 780 x 505 x 740 mm

OXO MULTI OALU 70 1Z KDP



OXO MULTI cabinet w. 900 mm with counter-top W/B, 1 drawer

Dimensions incl. washbasin (W x D x H): 980 x 505 x 740 mm

OXO MULTI OALU 90 1Z KDP



OXO MULTI cabinets with ceramic counter-top washbasins

Height of the washbasins is 130 mm.

OXO MULTI cabinet w. 1100 mm with counter-top W/B, 1 drawer

Dimensions incl. washbasin (W x D x H): 1180 x 505 x 520 mm

OXO MULTI 110 1Z KDP



 Counter-top washbasins (W x D x H) 800 x 420 x 130 mm

OXO MULTI cabinet w. 1100 mm with counter-top W/B, 1 drawer

Dimensions incl. washbasin (W x D x H): 1180 x 505 x 740 mm

OXO MULTI OALU 110 1Z KDP



OXO MULTI cabinet w. 1200 mm with counter-top W/B, 1 drawer

Dimensions incl. washbasin (W x D x H): 1280 x 505 x 520 mm

OXO MULTI 120 1Z KDP



 Counter-top washbasins (W x D x H) 800 x 420 x 130 mm

OXO MULTI cabinet w. 1200 mm with counter-top W/B, 1 drawer

Dimensions incl. washbasin (W x D x H): 1280 x 505 x 740 mm

OXO MULTI OALU 120 1Z KDP



 Cover boards with towel holder

OXO MULTI cabinets with ceramic counter-top washbasins

Height of the washbasins is 130 mm.

OXO MULTI cabinet w. 1200 mm with counter-top W/B, 2 drawers

Dimensions incl. washbasin (W x D x H): 1280 x 505 x 520 mm

OXO MULTI 120P 2Z KDP



➤ Counter-top washbasins (W x D x H) 500 x 420 x 130 mm

OXO MULTI cabinet w. 1200 mm with counter-top W/B, 2 drawers

Dimensions incl. washbasin (W x D x H): 1280 x 505 x 740 mm

OXO MULTI OALU 120P 2Z KDP



OXO MULTI cabinet w. 1200 mm with counter-top W/B, 2 drawers

Dimensions incl. washbasin (W x D x H): 1280 x 505 x 520 mm

OXO MULTI 120L 2Z KDL



➤ Counter-top washbasins (W x D x H) 500 x 420 x 130 mm

OXO MULTI cabinet w. 1200 mm with counter-top W/B, 2 drawers

Dimensions incl. washbasin (W x D x H): 1280 x 505 x 740 mm

OXO MULTI OALU 120L 2Z KDL



➤ Cover boards with towel holder

OXO MULTI cabinets with ceramic counter-top washbasins

Height of the washbasins is 130 mm.

OXO MULTI cabinet w. 1200 mm with 2 counter-top W/B's, 2 drawers

Dimensions incl. washbasin (W x D x H): 1280 x 505 x 520 mm

OXO MULTI 120D 2Z KDP



➤ Water outlets C/C 600 mm

➤ Counter-top washbasins (W x D x H) 500 x 420 x 130 mm

OXO MULTI cabinet w. 1400 mm with 2 counter-top W/B's, 2 drawers

Dimensions incl. washbasin (W x D x H): 1480 x 505 x 520 mm

OXO MULTI 140D 2Z KDP



➤ Water outlets C/C 700 mm

➤ Counter-top washbasins (W x D x H) 600 x 420 x 130 mm

OXO MULTI cabinet w. 1200 mm with 2 counter-top W/B's, 2 drawers

Dimensions incl. washbasin (W x D x H): 1280 x 505 x 740 mm

OXO MULTI OALU 120D 2Z KDP



➤ Counter-top washbasins (W x D x H) 500 x 420 x 130 mm

➤ Cover boards with towel holder

OXO MULTI cabinet w. 1400 mm with 2 counter-top W/B's, 2 drawers

Dimensions incl. washbasin (W x D x H): 1480 x 505 x 740 mm

OXO MULTI OALU 140D 2Z KDP



➤ Counter-top washbasins (W x D x H) 600 x 420 x 130 mm

OXO MULTI cabinets with ceramic counter-top washbasins

Height of the washbasins is 130 mm.

OXO MULTI cabinet w. 600 mm with counter-top W/B, 2 drawers

Dimensions incl. washbasin (W x D x H): 680 x 505 x 720 mm

OXO MULTI 60 2Z KDP



➤ Counter-top washbasins (W x D x H) 500 x 420 x 130 mm

OXO MULTI cabinet w. 700 mm with counter-top W/B, 2 drawers

Dimensions incl. washbasin (W x D x H): 780 x 505 x 720 mm

OXO MULTI 70 2Z KDP



➤ Counter-top washbasins (W x D x H) 600 x 420 x 130 mm

OXO MULTI cabinet w. 900 mm with counter-top W/B, 2 drawers

Dimensions incl. washbasin (W x D x H): 980 x 505 x 720 mm

OXO MULTI 90 2Z KDP



➤ Counter-top washbasins (W x D x H) 600 x 420 x 130 mm

OXO MULTI cabinet w. 1100 mm with counter-top W/B, 2 drawers

Dimensions incl. washbasin (W x D x H): 1180 x 505 x 720 mm

OXO MULTI 110 2Z KDP



➤ Counter-top washbasins (W x D x H) 800 x 420 x 130 mm

➤ Cover boards with towel holder

OXO MULTI cabinets with ceramic counter-top washbasins

Height of the washbasins is 130 mm.

OXO MULTI cabinet w. 1200 mm with counter-top W/B, 4 drawers

Dimensions incl. washbasin (W x D x H): 1280 x 505 x 720 mm

OXO MULTI 120P 4Z KDP



OXO MULTI cabinet w. 1200 mm with counter-top W/B, 4 drawers

Dimensions incl. washbasin (W x D x H): 1280 x 505 x 720 mm

OXO MULTI 120L 4Z KDL



▶ Counter-top washbasins (W x D x H) 500 x 420 x 130 mm

▶ Counter-top washbasins (W x D x H) 500 x 420 x 130 mm

OXO MULTI cabinet w. 1200 mm with counter-top W/B, 2 drawers

Dimensions incl. washbasin (W x D x H): 1280 x 505 x 720 mm

OXO MULTI 120 2Z KDP



OXO MULTI cabinet w. 1200 mm with 2 counter-top W/B's, 4 drawers

Dimensions incl. washbasin (W x D x H): 1280 x 505 x 720 mm

OXO MULTI 120D 4Z KDP



▶ Counter-top washbasins (W x D x H) 800 x 420 x 130 mm

▶ Counter-top washbasins (W x D x H) 500 x 420 x 130 mm

▶ Cover boards with towel holder

▶ Water outlets C/C 600 mm



OXO MULTI

OXO MULTI cabinet w. 1400 mm with 2 counter-top W/B's, 4 drawers

Dimensions incl. washbasin (W x D x H): 1480 x 505 x 720 mm

OXO MULTI 140D 4Z KDP



➤ Counter-top washbasins (W x D x H) 600 x 420 x 130 mm

➤ Water outlets C/C 700 mm



➤ Cover boards with towel holder

OXO MULTI cabinets with ceramic counter-top washbasins

Height of the washbasins is 130 mm.

OXO MULTI cabinet w. 1200 mm with counter-top W/B, 1 drawer
 Dimensions incl. washbasin (W x D x H): 1280 x 505 x 520 mm
 OXO MULTI 120P 60 1Z KDP



OXO MULTI cabinet w. 1200 mm with counter-top W/B, 1 drawer
 Dimensions incl. washbasin (W x D x H): 1280 x 505 x 740 mm
 OXO MULTI OALU 120P 60 1Z KDP



▶ Counter-top washbasins (W x D x H) 500 x 420 x 130 mm

▶ Open shelf on the left

OXO MULTI cabinet w. 1200 mm with counter-top W/B, 1 drawer
 Dimensions incl. washbasin (W x D x H): 1280 x 505 x 520 mm
 OXO MULTI 120L 60 1Z KDL



OXO MULTI cabinet w. 1200 mm with counter-top W/B, 1 drawer
 Dimensions incl. washbasin (W x D x H): 1280 x 505 x 740 mm
 OXO MULTI OALU 120L 60 1Z KDL



▶ Counter-top washbasins (W x D x H) 500 x 420 x 130 mm

▶ Open shelf on the right

▶ Cover boards with towel holder

OXO MULTI cabinets with ceramic counter-top washbasins

Height of the washbasins is 130 mm.

OXO MULTI cabinet w. 1400 mm with counter-top W/B, 1 drawer

Dimensions incl. washbasin (W x D x H): 1480 x 505 x 520 mm

OXO MULTI 140P 70 1Z KDP



➤ Counter-top washbasins (W x D x H) 600 x 420 x 130 mm

➤ Open shelf on the left

OXO MULTI cabinet w. 1400 mm with counter-top W/B, 1 drawer

Dimensions incl. washbasin (W x D x H): 1480 x 505 x 740 mm

OXO MULTI OALU 140P 70 1Z KDP



➤ Counter-top washbasins (W x D x H) 600 x 420 x 130 mm

➤ Open shelf on the left

➤ Cover boards with towel holder

OXO MULTI cabinets with ceramic counter-top washbasins

Height of the washbasins is 130 mm.

OXO MULTI cabinet w. 1400 mm with counter-top W/B, 1 drawer

Dimensions incl. washbasin (W x D x H): 1480 x 505 x 520 mm

OXO MULTI 140L 70 1Z KDL



➤ Counter-top washbasins (W x D x H) 600 x 420 x 130 mm

➤ Open shelf on the right

OXO MULTI cabinet w. 1400 mm with counter-top W/B, 1 drawer

Dimensions incl. washbasin (W x D x H): 1480 x 505 x 740 mm

OXO MULTI OALU 140L 70 1Z KDL



➤ Counter-top washbasins (W x D x H) 600 x 420 x 130 mm

➤ Open shelf on the right

➤ Cover boards with towel holder



OXO MULTI

Cabinets with ceramic washbasin **CeraStyle PINTO** in sizes 75, 100, 120 a 150 cm, with depth 46,5 cm, are available in 12 deep matt colors.

OXO MULTI furniture is produced of a beech Multiplex. The beech plywood is highly resistant to scratches and the antibacterial surface has a protection against fingerprints. Cabinets are equipped with **Hettich InnoTech Atira** drawer system with a popular handleless push-to-open system.

For even better functionality, the drawers from width 51cm are fitted with an opening synchronization. The storage space can be extended by an **OALU** open-shelf placed under the furniture.

Accessories - see from page 138.

- With variants with the **OALU** open shelf placed under the furniture you will get more airy storage space.
- The constructions of the **OALU** shelves are made of thin-walled aluminium profiles of thickness 2 x 2 cm, in silver-grey color. The base-plate inside the open shelf is made of a board in the same color as furniture.
- The cabinets are supplied fully assembled and ready for installation.

OXO MULTI cabinets with ceramic washbasin

Height of the washbasins is 130 mm.

OXO MULTI cabinet w. 750 mm with washbasin, 1 drawer
 Dimensions incl. washbasin (W x D x H): 750 x 465 x 490 mm
OXO MULTI 75 1Z



OXO MULTI cabinet w. 750 mm with washbasin, 1 drawer
 Dimensions incl. washbasin (W x D x H): 750 x 465 x 710 mm
OXO MULTI OALU 75 1Z



OXO MULTI cabinet w. 1000 mm with washbasin, 1 drawer
 Dimensions incl. washbasin (W x D x H): 1000 x 465 x 490 mm
OXO MULTI 100 1Z



OXO MULTI cabinet w. 1000 mm with washbasin, 1 drawer
 Dimensions incl. washbasin (W x D x H): 1000 x 465 x 710 mm
OXO MULTI OALU 100 1Z



OXO MULTI cabinet w. 1000 mm with washbasin, 1 drawer
 Dimensions incl. washbasin (W x D x H): 1000 x 465 x 490 mm
OXO MULTI 100D 1Z



OXO MULTI cabinet w. 1000 mm with washbasin, 1 drawer
 Dimensions incl. washbasin (W x D x H): 1000 x 465 x 710 mm
OXO MULTI OALU 100D 1Z



 Depth of the washbasin cabinets is 450 mm

OXO MULTI cabinets with ceramic washbasin

Height of the washbasins is 130 mm.

OXO MULTI cabinet w. 1200 mm with washbasin, 2 drawer
 Dimensions incl. washbasin (W x D x H): 1200 x 465 x 490 mm
OXO MULTI 120D 2Z



OXO MULTI cabinet w. 1200 mm with washbasin, 2 drawer
 Dimensions incl. washbasin (W x D x H): 1200 x 465 x 710 mm
OXO MULTI OALU 120D 2Z



 Water outlets C/C 590 mm

OXO MULTI cabinet w. 1500 mm with washbasin, 2 drawer
 Dimensions incl. washbasin (W x D x H): 1500 x 465 x 490 mm
OXO MULTI 150D 2Z



OXO MULTI cabinet w. 1500 mm with washbasin, 2 drawer
 Dimensions incl. washbasin (W x D x H): 1500 x 465 x 710 mm
OXO MULTI OALU 150D 2Z



 Water outlets C/C 650 mm

 Depth of the washbasin cabinets is 450 mm

OXO MULTI cabinets with ceramic washbasin

Height of the washbasins is 130 mm.

OXO MULTI cabinet w. 750 mm with washbasin, 2 drawer
Dimensions incl. washbasin (W x D x H): 750 x 465 x 710 mm
OXO MULTI 75 2Z



OXO MULTI cabinet w. 1000 mm with washbasin, 2 drawer
Dimensions incl. washbasin (W x D x H): 1000 x 465 x 710 mm
OXO MULTI 100 2Z



OXO MULTI cabinet w. 1000 mm with washbasin, 2 drawer
Dimensions incl. washbasin (W x D x H): 1000 x 465 x 710 mm
OXO MULTI 100D 2Z



OXO MULTI cabinet w. 1200 mm with washbasin, 4 drawer
Dimensions incl. washbasin (W x D x H): 1200 x 465 x 710 mm
OXO MULTI 120D 4Z



OXO MULTI cabinet w. 1500 mm with washbasin, 4 drawer
Dimensions incl. washbasin (W x D x H): 1500 x 465 x 710 mm
OXO MULTI 150D 4Z

 Water outlets C/C 590 mm



 Water outlets C/C 650 mm

 Depth of the washbasin cabinets is 450 mm

OXO MULTI side cabinets

 Adjustable glass-shelves

OXO MULTI high cabinet 50, 4 doors
(W x D x H): 500 x 350 x 1560 mm
OXO MULTI SV 50 4D





OXO MULTI high cabinet 35, 2 doors
(W x D x H): 350 x 350 x 1560 mm
OXO MULTI SV 35 2D P



OXO MULTI high cabinet 35, 2 doors
(W x D x H): 350 x 350 x 1560 mm
OXO MULTI SV 35 2D L



 Right - hinges on the right

 Left - hinges on the left

OXO MULTI low cabinet 35, 1 door
(W x D x H): 350 x 350 x 780 mm
OXO MULTI SN 35 1D P



OXO MULTI low cabinet 35, 1 door
(W x D x H): 350 x 350 x 780 mm
OXO MULTI SN 35 1D L



 Right - hinges on the right

 Left - hinges on the left

OXO MULTI side cabinets

 Adjustable glass-shelves

OXO MULTI high cabinet 50, 4 doors
(W x D x H): 500 x 350 x 1780 mm
OXO MULTI OALU SV 50 4D



OXO MULTI high cabinet 35, 2 doors
(W x D x H): 350 x 350 x 1780 mm
OXO MULTI OALU SV 35 2D P



OXO MULTI high cabinet 35, 2 doors
(W x D x H): 350 x 350 x 1780 mm
OXO MULTI OALU SV 35 2D L



 Right - hinges on the right

 Left - hinges on the left

OXO MULTI low cabinet 35, 1 door
(W x D x H): 350 x 350 x 1000 mm
OXO MULTI OALU SN 35 1D P



OXO MULTI low cabinet 35, 1 door
(W x D x H): 350 x 350 x 1000 mm
OXO MULTI OALU SN 35 1D L



 Right - hinges on the right

 Left - hinges on the left



OXO MULTI

Side cabinets

The side cabinets are made in the same design as washbasin cabinets. Cabinets are equipped with **Hettich Innotech Atira** drawer system. Cabinets with doors come with handleless **Push to open** system and adjustable glass shelves. Depth of the side cabinets is 35 cm. The storage space can be extended by the **OALU** shelf placed under the furniture.

Accessories - see page 138.

- With variants with the **OALU** open shelf placed under the furniture you will get more airy storage space.
- The constructions of the **OALU** shelves are made of thin-walled aluminium profiles of thickness 2 x 2 cm, in silver-grey color. The base-plate inside the open shelf is made of a board in the same color as furniture.
- The cabinets are supplied fully assembled and ready for installation.

OXO MULTI side cabinets

 Adjustable glass-shelves

OXO MULTI high cabinet 80, 2 doors
(W x D x H): 800 x 350 x 1560 mm
OXO MULTI SV 80 2DW1Z



OXO MULTI high cabinet 80, 2 doors
(W x D x H): 800 x 350 x 1780 mm
OXO MULTI OALU SV 80 2DW1Z



 Folding doors system
HETTICH WingLine

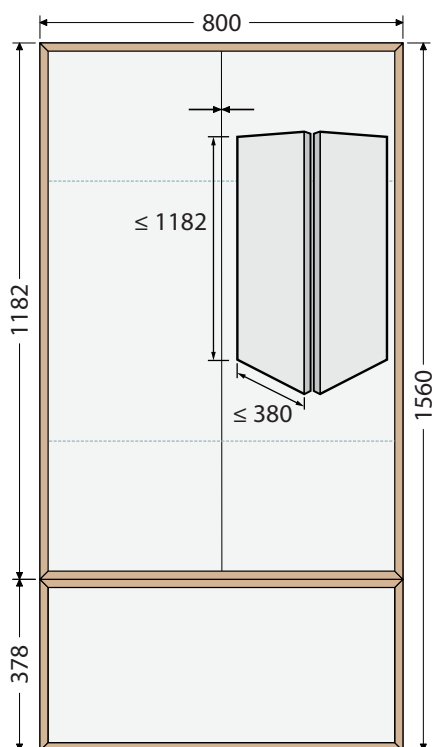



OXO ALU

Additional shelves **OXO ALU** are made of painted thin-walled aluminium profiles 2 x 2 cm. ALU constructions are available in black or silver-grey color. For the base-plate inside OALU, please select the same color as you did for your furniture. Otherwise see colors on page **78**.

Colors of the ALU constructions



 The OALU shelves are supplied fully assembled and ready for installation.

OXO ALU stand-alone open shelves

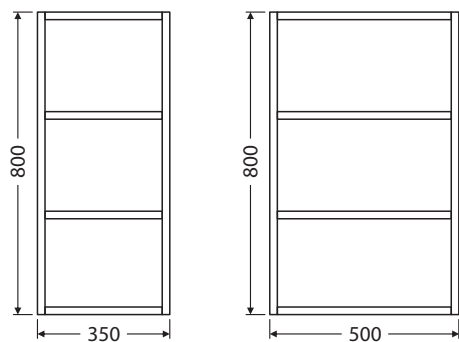

OALU 35/80 B
OALU 35/80 S

OALU 50/80 B
OALU 50/80 S

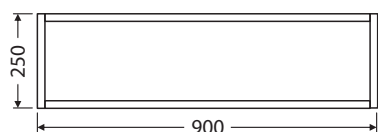

OALU 90/25 B
OALU 90/25 S

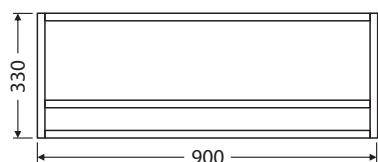
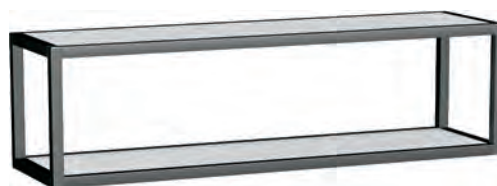

OALU 90/33 B
OALU 90/33 S

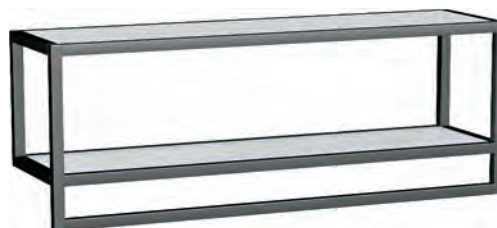

 Towel holder

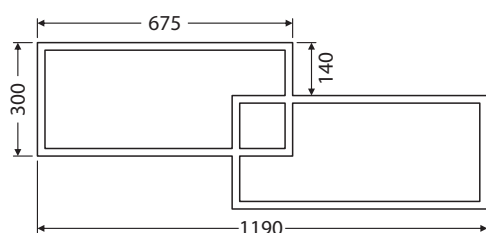

OALU 119/44 B
OALU 119/44 S

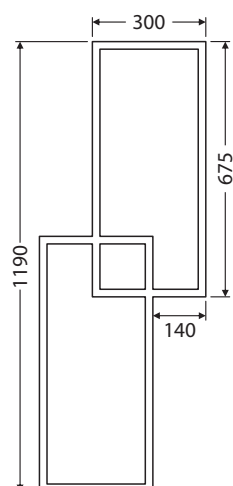
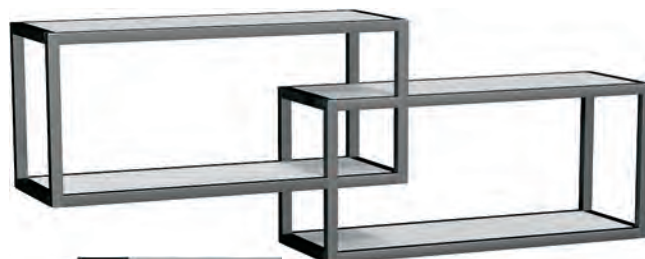

OALU 44/119 B
OALU 44/119 S



 Depth of the shelves 240 mm



BRAVE
BRAVE





BRAVE

Bathroom furniture **BRAVE** comes with ceramic washbasins in sizes 61, 71, 81, 91, 101 and 121 cm. Depth of the washbasins is 46 cm.

Bathroom furniture **BRAVE DESK** comes with ceramic counter-top washbasins in sizes 50 and 60 cm, depth 42 cm. Cabinets are equipped with modern soft-close drawer system **StrongMax**.

Accessories - see from page 138.



The cabinets are always supplied fully assembled and ready for installation.

How to order a washbasin cabinet and a side cabinet BRAVE

- 1) Choose a cabinet.
- 2) Choose a color.
- 3) Follow the same steps to order a side cabinet.
- 4) Accessories like faucets, siphons, different organization trays and others, you can find from page 138.
- 5) Mirrors, mirror cabinets and lamps you can choose starting from page 118.

E.g.	Furniture code BR 60 2Z	Color A0016
------	-----------------------------------	-----------------------

E.g.	Furniture code BR SV 35 2D L	Color A0076
------	--	-----------------------

L = hinges on the left side
P = hinges on the right side

1-2D = number of doors (side cabinets)
2Z = number of drawers
HZ = upper cabinet
SV = high cabinet



Plumbing installation heights

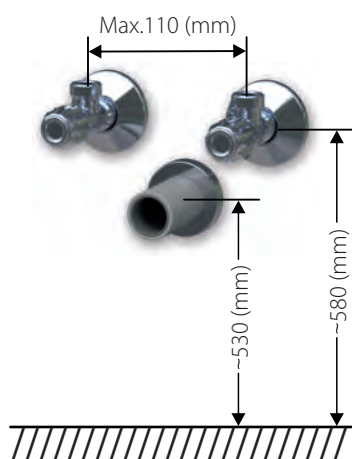

➤ Recommended saving siphon OXO D US660, with adjustable height and depth, for furniture washbasins, to be found on page 149.



Wood colors

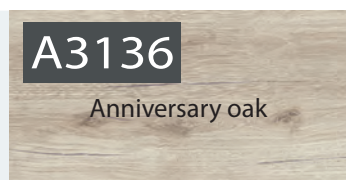

➤ Handle BRAVE



Painted colors



➤ Wood-colors have distinctive wood-structures and painted colors are lacquered in hi-gloss finish. Melamine faced and painted boards have excellent antibacterial properties with a capability of significant reduction of bacteria and germs on the furniture surface within 24 hours.

BRAVE cabinets with ceramic washbasin

Height of the washbasins is 15 mm.

BRAVE cabinet with washbasin w. 610 mm, 2 drawers

Dimensions incl. washbasin (W x D x H): 610 x 460 x 595 mm

BR 60 2Z



BRAVE cabinet with washbasin w. 710 mm, 2 drawers

Dimensions incl. washbasin (W x D x H): 710 x 460 x 595 mm

BR 70 2Z



BRAVE cabinet with washbasin w. 810 mm, 2 drawers

Dimensions incl. washbasin (W x D x H): 810 x 460 x 595 mm

BR 80 2Z



BRAVE cabinet with washbasin w. 910 mm, 2 drawers

Dimensions incl. washbasin (W x D x H): 910 x 460 x 595 mm

BR 90 2Z



BRAVE cabinet with washbasin w. 1010 mm, 2 drawers

Dimensions incl. washbasin (W x D x H): 1010 x 460 x 595 mm

BR 100 2Z



BRAVE cabinet with washbasin w. 1210 mm, 2 drawers

Dimensions incl. washbasin (W x D x H): 1210 x 460 x 595 mm

BR 120 2Z



Water outlets C/C 600 mm

BRAVE DESK cabinets with ceramic counter-top washbasins

Height of the washbasins is 130 mm.

BRAVE cabinet w. 600 mm with counter-top W/B, 2 drawers

Dimensions incl. washbasin (W x D x H): 600 x 460 x 746 mm

BR DESK 60 2Z



BRAVE cabinet w. 700 mm with counter-top W/B, 2 drawers

Dimensions incl. washbasin (W x D x H): 700 x 460 x 746 mm

BR DESK 70 2Z



 Counter-top washbasins (W x D x H) 500 x 420 x 130 mm

BRAVE cabinet w. 800 mm with counter-top W/B, 2 drawers

Dimensions incl. washbasin (W x D x H): 800 x 460 x 746 mm

BR DESK 80 2Z



BRAVE cabinet w. 900 mm with counter-top W/B, 2 drawers

Dimensions incl. washbasin (W x D x H): 900 x 460 x 746 mm

BR DESK 90 2Z



 Counter-top washbasins (W x D x H) 600 x 420 x 130 mm

BRAVE DESK cabinets with ceramic counter-top washbasins

Height of the washbasins is 130 mm.

BRAVE cabinet w. 1000 mm with counter-top W/B, 2 drawers

Dimensions incl. washbasin (W x D x H): 1000 x 460 x 746 mm

BR DESK 100 2Z



BRAVE cabinet w. 1200 mm with counter-top W/B, 2 drawers

Dimensions incl. washbasin (W x D x H): 1200 x 460 x 746 mm

BR DESK 120 2Z



➤ Counter-top washbasins (W x D x H) 600 x 420 x 130 mm

⬆ Water outlets C/C 600 mm

➤ Counter-top washbasins (W x D x H) 500 x 420 x 130 mm

BRAVE side cabinets

➤ Adjustable glass shelves

➤ Right - hinges on the right

➤ Left - hinges on the left

BRAVE high cabinet 35, 2 doors, right

Dimensions (W x D x H): 350 x 350 x 1620 mm

BR SV 35 2D P

BRAVE high cabinet 35, 2 doors, left

Dimensions (W x D x H): 350 x 350 x 1620 mm

BR SV 35 2D L



BRAVE side cabinets

 Adjustable glass-shelves



BRAVE upper cabinet 35, 1 door, right
(W x D x H): 350 x 230 x 820 mm
BR HZ 35 1D P



 Right - hinges on the right

BRAVE upper cabinet 35, 1 door, left
(W x D x H): 350 x 230 x 820 mm
BR HZ 35 1D L



 Left - hinges on the left

BRAVE high cabinet 35, 2 doors, right, bin
(W x D x H): 350 x 350 x 1600 mm
BR SV 35 2D P K

BRAVE high cabinet 35, 2 doors, left, bin
(W x D x H): 350 x 350 x 1600 mm
BR SV 35 2D L K



 Right - hinges on the right

 Left - hinges on the left

BRAVE low cabinet 35, 1 door, right
(W x D x H): 350 x 350 x 820 mm
BR SN 35 1D P



 Right - hinges on the right

BRAVE low cabinet 35, 1 door, left
(W x D x H): 350 x 350 x 820 mm
BR SN 35 1D L



 Left - hinges on the left

BRAVE low cabinet 35, 1 door, bin
(W x D x H): 350 x 350 x 820 mm
BR SN 35 1D K

 Removable laundry bin





How to order

General information on ordering washbasin cabinets and side cabinets for series STORM NEW, GUEST, BOX, DESK NEW, FORTY, IDEAL and UNI.



The cabinets are always supplied fully assembled and ready for installation.

How to order washbasin cabinets and side cabinets

- 1) Choose a cabinet.
- 2) Choose a color from page 78. (Seires **FORTY** and **DESK NEW** have their own limited choice of colors.)
- 3) Choose a handle from page 79. (Handles can be chosen for series **GUEST**, **BOX** and side cabinets **UNI**.)
- 4) Follow the same steps to order a side cabinets.
- 5) Accessories like faucets, furniture legs, taps, siphons, etc., you can find from page 138.
- 6) Mirrors, mirror cabinets and lamps you can choose starting from page 118.

E.g.	Furniture code BOX ELITE 120D 1Z	Color A0016	Handle ID
E.g.	Furniture code UNI SV 190/65 2D OP	Color A0016	Handle ID

- L = hinges on the left side
 P = hinges on the right side
 K = laundry bin
 1- 4D = number of doors (side cabinets)
 1- 4Z = number of drawers



BOX ELITE 120D 1Z



UNI SV 190/65 2D OP

Plumbing installation heights

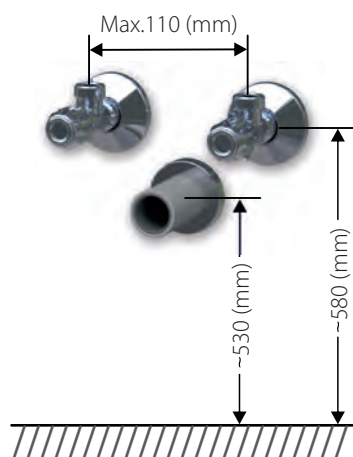



- Recommended saving siphon **OXO D US660**, with adjustable height and depth, for furniture washbasins, to be found on page 149.

- Melamine faced and painted boards have excellent antibacterial properties with a capability of significant reduction of bacteria and germs on the furniture surface within 24 hours.



Wood colors

 All colors at the same price

24 Woodline creme	25 Tobacco Gladstone oak	26 Grey-beige Gladstone oak	31 Natural Nebraska oak
32 Grey Nebraska oak	34 Tobacco Aida walnut	37 Dijon walnut	50 Grey Arizona oak
51 Brown Arizona oak	55 Wenge	70 Natural Kendal oak	80 Natural Halifax oak
81 Hacienda black	94 Patina Bronze	99 Black-brown Thermo oak	K011 Cream Loft pine
D370 Wellington oak	D331 Chamonix oak	A3136 Anniversary oak	
A4376 Factory 01 concrete	A4386 Factory 02 concrete	 Antibacterial surface properties	

Melamine faced and painted boards have excellent antibacterial properties with a capability of significant reduction of bacteria and germs on the furniture surface within 24 hours.

Painted colors

A0016 White GLOSSY	A0025 Magnolia GLOSSY	A0076 Anthracite GLOSSY	A0086 Black GLOSSY	A2496 Basalto GLOSSY	A2736 Light grey GLOSSY	A3026 Cashmere GLOSSY	A3166 Cuzco Grafit GLOSSY
A4606 Art oak GLOSSY	A3416 White MATT	A3396 Anthracite MATT	A3686 Black MATT	A3406 Basalto MATT	A5866 Light grey MATT	A3746 Cashmere MATT	A9166 Marino blue MATT
A5606 Indigo blue MATT	A6766 Aqua Marina MATT	A9146 Salvia green MATT	A4706 Plomo grey MATT	A9556 Cotto MATT	A7356 Light Gold MATT	A4536 Oriental White MATT	A4546 Oriental Black MATT

Matt colors have an anti-fingerprint protection.

Displayed colors can be chosen for series **STORM NEW**, **GUEST**, **BOX**, **FORTY**, **DESK NEW**, **IDEAL** and side cabinets **UNI**.

Print of the displayed colors has an informative character only.

Handles Glossy (G)



All handle types at the same price

Selection of handles for series GUEST, BOX and side cabinets UNI.

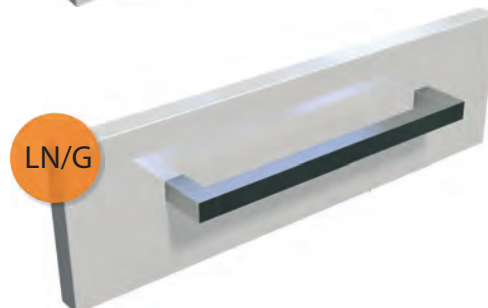
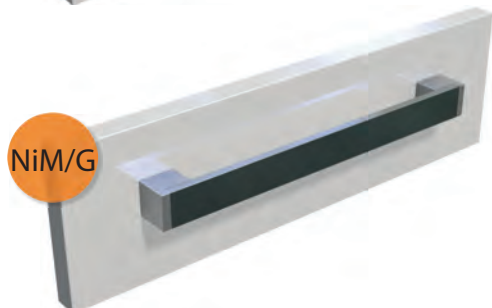
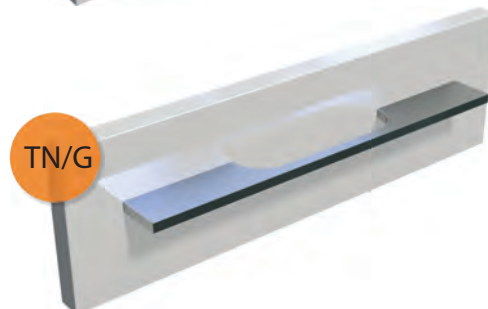
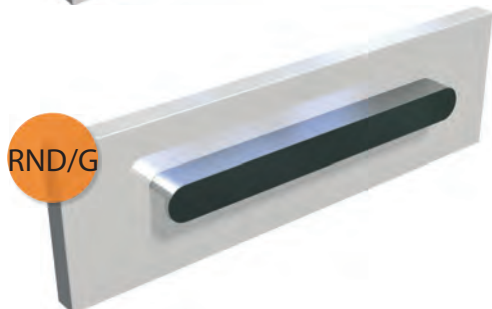
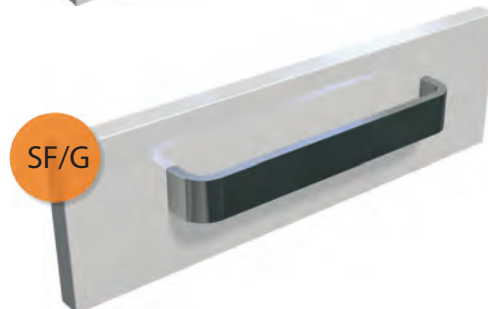
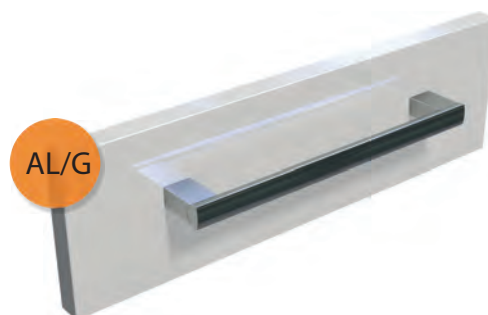
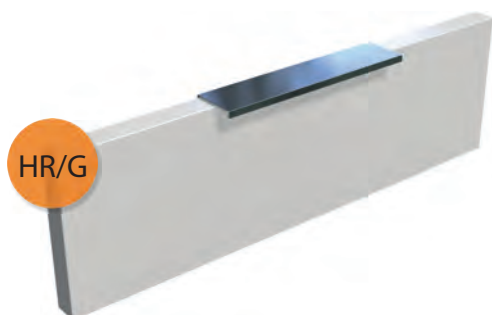

Handleless push-to-open version



Matt black color



STORM NEW

STORM NEW





STORM NEW

Bathroom furniture **STORM NEW** is fitted with ceramic washbasins **CeraStyle PINTO** in sizes 75, 100, 120 and 150 cm, with depth of 46,5 cm.

The cabinets are equipped with a modern soft-close drawer system **StrongMax**.

Accessories - see page 138.

Available colors - see page 78.



The cabinets are supplied fully assembled and ready for installation.

STORM NEW cabinets with ceramic washbasin

Height of the washbasins is 130 mm.

STORM NEW cabinet w. 750 mm with washbasin, 2 drawers

Dimensions incl. washbasin (W x D x H): 750 x 465 x 660 mm

STORM NEW 75 2Z



STORM NEW cabinet w. 1000 mm with washbasin, 2 drawers

Dimensions incl. washbasin (W x D x H): 1000 x 465 x 660 mm

STORM NEW 100 2Z



STORM NEW cabinet w. 1000 mm with washbasin, 2 drawers

Dimensions incl. washbasin (W x D x H): 1000 x 465 x 660 mm

STORM NEW 100D 2Z



STORM NEW cabinet w. 1200 mm with washbasin, 4 drawers

Dimensions incl. washbasin (W x D x H): 1200 x 465 x 660 mm

STORM NEW 120D 4Z



 Depth of the washbasin cabinets is 450 mm

 Water outlets C/C 590 mm

 Recommended saving siphon **OXO D US660**, with adjustable height and depth, for furniture washbasins, to be found on page **149**.



STORM NEW



Information on how to order STORM NEW furniture - see page 77.

STORM NEW cabinets with ceramic washbasin

Height of the washbasins is 130 mm.

STORM NEW cabinet w. 1500 mm with washbasin, 4 drawers

Dimensions incl. washbasin (W x D x H): 1500 x 465 x 660 mm

STORM NEW 150D 4Z



STORM NEW 150D 4Z - Detail

➤ Water outlets C/C 650 mm

➤ Depth of the washbasin cabinets is 450 mm

STORM NEW side cabinets

➤ Right - hinges on the right

STORM NEW high cabinet 35, 1 door, 2 drawers, right

(W x D x H): 350 x 340 x 1700 mm

STORM NEW SV 170/35 1D 2Z P

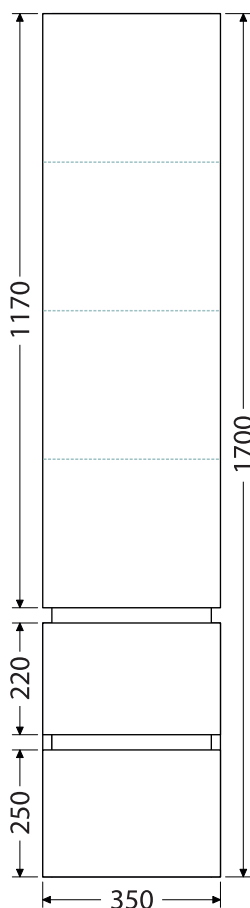

➤ Left - hinges on the left

STORM NEW high cabinet 35, 1 door, 2 drawers, left

(W x D x H): 350 x 340 x 1700 mm

STORM NEW SV 170/35 1D 2Z L



➤ Adjustable glass-shelves





GUEST

GUEST



Information on how to order GUEST furniture - see page 77.



GUEST cabinets with washbasin

Height of the washbasins is 20 mm.

GUEST cabinet w. 420 mm with washbasin, 1 door

Dimensions incl. washbasin (W x D x H): 420 x 225 x 490 mm

GUEST 40 P T

GUEST 40 L T



➤ Right - hinges on the right ➤ Left - hinges on the left

➤ Ceramic washbasins MINI

➤ Recommended saving siphon OXO D US660, with adjustable height and depth, for furniture washbasins, to be found on page 149.

GUEST cabinets with washbasin

Height of the washbasins is 70 mm.

GUEST cabinet w. 400 mm with washbasin, 1 door

Dimensions incl. washbasin (W x D x H): 400 x 220 x 540 mm

GUEST 40 P

GUEST 40 L



➤ Right - hinges on the right ➤ Left - hinges on the left

➤ Cast-marble washbasins

Bathroom furniture **GUEST** with ceramic washbasin **CeraStyle MINI** and cast-marble washbasin, with door version right or left.

Side cabinets **UNI** starting on page 108.

Accessories - see page 130.

➤ The cabinets are supplied fully assembled and ready for installation.



BOX
BOX



Bathroom furniture **BOX** offers a wide range of ceramic washbasins **CeraStyle ARTE** and **ELITE** to choose from.



BOX

➤ Information on **how to order BOX** furniture - see page 77.

BOX cabinets with ceramic washbasins **CeraStyle ARTE** in sizes 55, 65, 75, 85, 100 and 120 cm, with depth of 45 cm and ceramic washbasins **CeraStyle ELITE** in sizes 60, 70, 80, 90, 100 and 120 cm, with depth of 45 cm are available in versions with 1 or 2 drawers.

Cabinets are equipped with a soft-close drawer system **StrongBox**.

Side cabinets **UNI** starting on page 108.

Accessories - see page 138.

➤ The cabinets are supplied fully assembled and ready for installation.

BOX cabinets for ceramic washbasins CeraStyle ARTE and ELITE

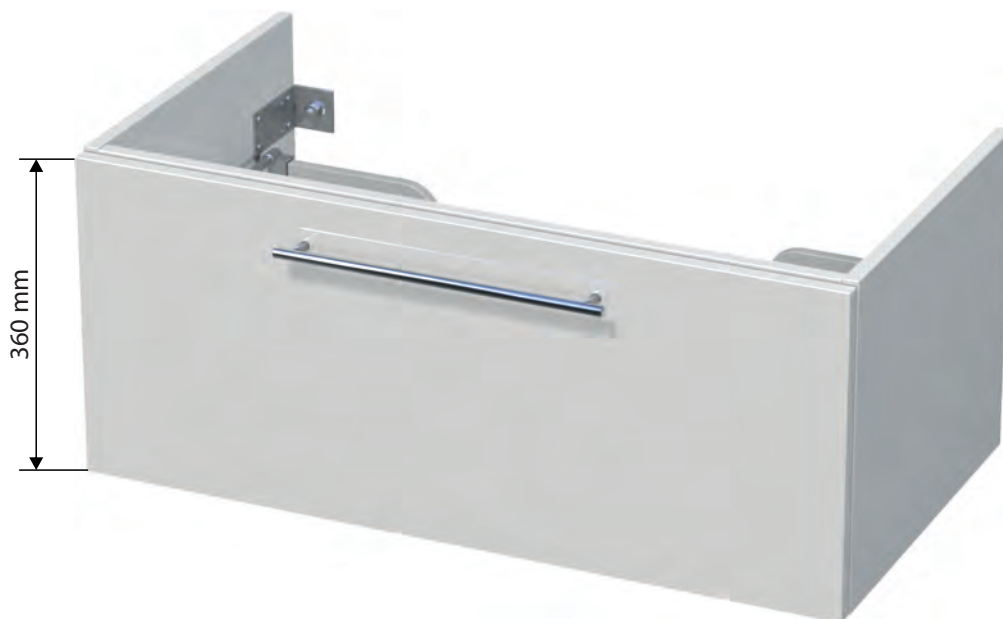

➤ Cabinet with 1 drawer

➤ Recommended saving siphon OXO D US660, with adjustable height and depth, for furniture washbasins, to be found on page 149.

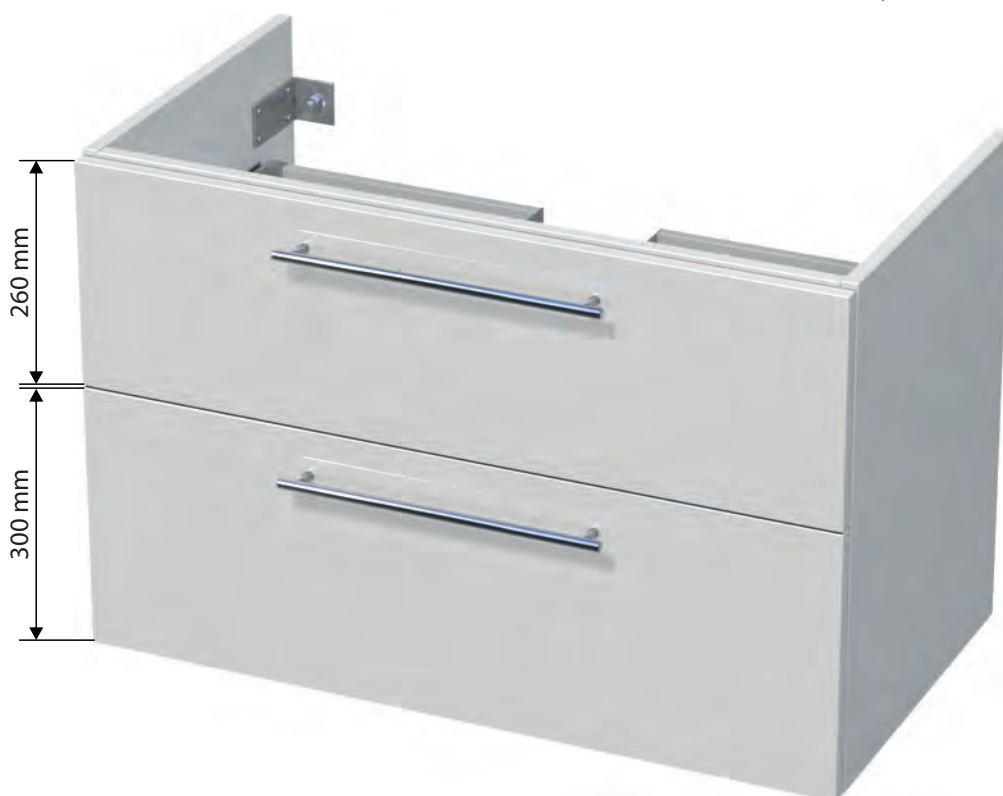

➤ Cabinet with 2 drawers

BOX cabinets with ceramic washbasin CeraStyle ARTE

Height of the washbasins is 20 mm.

BOX ARTE cabinet w. 550 mm with washbasin, 1 drawer
 Dimensions incl. washbasin (W x D x H): 550 x 370 x 380 mm
BOX ARTE 55 1Z



▶ Depth of the washbasin cabinets is 350 mm

BOX ARTE cabinet w. 750 mm with washbasin, 1 drawer
 Dimensions incl. washbasin (W x D x H): 750 x 450 x 380 mm
BOX ARTE 75 1Z



BOX ARTE cabinet w. 1000 mm with washbasin, 1 drawer
 Dimensions incl. washbasin (W x D x H): 1000 x 450 x 380 mm
BOX ARTE 100 1Z



BOX ARTE cabinet w. 650 mm with washbasin, 1 drawer
 Dimensions incl. washbasin (W x D x H): 650 x 450 x 380 mm
BOX ARTE 65 1Z



▶ Depth of the washbasin cabinets is 440 mm

BOX ARTE cabinet w. 850 mm with washbasin, 1 drawer
 Dimensions incl. washbasin (W x D x H): 850 x 450 x 380 mm
BOX ARTE 85 1Z



BOX ARTE cabinet w. 1200 mm with washbasin, 1 drawer
 Dimensions incl. washbasin (W x D x H): 1200 x 450 x 380 mm
BOX ARTE 120D 1Z



▶ Water outlets C/C 530 mm

BOX cabinets with ceramic washbasin CeraStyle ARTE

Height of the washbasins is 20 mm.

BOX ARTE cabinet w. 550 mm with washbasin, 2 drawers
Dimensions incl. washbasin (W x D x H): 550 x 370 x 580 mm
BOX ARTE 55 2Z



▶ Depth of the washbasin cabinets is 350 mm

BOX ARTE cabinet w. 750 mm with washbasin, 2 drawers
Dimensions incl. washbasin (W x D x H): 750 x 450 x 580 mm
BOX ARTE 75 2Z



BOX ARTE cabinet w. 1000 mm with washbasin, 2 drawers
Dimensions incl. washbasin (W x D x H): 1000 x 450 x 580 mm
BOX ARTE 100 2Z



BOX ARTE cabinet w. 650 mm with washbasin, 2 drawers
Dimensions incl. washbasin (W x D x H): 650 x 450 x 580 mm
BOX ARTE 65 2Z



▶ Depth of the washbasin cabinets is 440 mm

BOX ARTE cabinet w. 850 mm with washbasin, 2 drawers
Dimensions incl. washbasin (W x D x H): 850 x 450 x 580 mm
BOX ARTE 85 2Z



BOX ARTE cabinet w. 1200 mm with washbasin, 2 drawers
Dimensions incl. washbasin (W x D x H): 1200 x 450 x 580 mm
BOX ARTE 120D 2Z



▶ Water outlets C/C 530 mm

BOX cabinets with ceramic washbasin CeraStyle ELITE

Height of the washbasins is 50 mm.

BOX ELITE cabinet w. 600 mm with washbasin, 1 drawer
 Dimensions incl. washbasin (W x D x H): 600 x 450 x 410 mm
BOX ELITE 60 1Z



BOX ELITE cabinet w. 700 mm with washbasin, 1 drawer
 Dimensions incl. washbasin (W x D x H): 700 x 450 x 410 mm
BOX ELITE 70 1Z



BOX ELITE cabinet w. 800 mm with washbasin, 1 drawer
 Dimensions incl. washbasin (W x D x H): 800 x 450 x 410 mm
BOX ELITE 80 1Z



BOX ELITE cabinet w. 900 mm with washbasin, 1 drawer
 Dimensions incl. washbasin (W x D x H): 900 x 450 x 410 mm
BOX ELITE 90 1Z



BOX ELITE cabinet w. 1000 mm with washbasin, 1 drawer
 Dimensions incl. washbasin (W x D x H): 1000 x 450 x 410 mm
BOX ELITE 100 1Z



BOX ELITE cabinet w. 1200 mm with washbasin, 1 drawer
 Dimensions incl. washbasin (W x D x H): 1200 x 450 x 410 mm
BOX ELITE 120D 1Z



 Depth of the washbasin cabinets is 430 mm

 Water outlets C/C 600 mm

BOX cabinets with ceramic washbasin CeraStyle ELITE

Height of the washbasins is 50 mm.

BOX ELITE cabinet w. 600 mm with washbasin, 2 drawers
 Dimensions incl. washbasin (W x D x H): 600 x 450 x 610 mm
BOX ELITE 60 2Z



BOX ELITE cabinet w. 700 mm with washbasin, 2 drawers
 Dimensions incl. washbasin (W x D x H): 700 x 450 x 610 mm
BOX ELITE 70 2Z



BOX ELITE cabinet w. 800 mm with washbasin, 2 drawers
 Dimensions incl. washbasin (W x D x H): 800 x 450 x 610 mm
BOX ELITE 80 2Z



BOX ELITE cabinet w. 900 mm with washbasin, 2 drawers
 Dimensions incl. washbasin (W x D x H): 900 x 450 x 610 mm
BOX ELITE 90 2Z



BOX ELITE cabinet w. 1000 mm with washbasin, 2 drawers
 Dimensions incl. washbasin (W x D x H): 1000 x 450 x 610 mm
BOX ELITE 100 2Z



BOX ELITE cabinet w. 1200 mm with washbasin, 2 drawers
 Dimensions incl. washbasin (W x D x H): 1200 x 450 x 610 mm
BOX ELITE 120D 2Z



 Depth of the washbasin cabinets is 430 mm

 Water outlets C/C 600 mm



DESK NEW

- ▶ Information on **how to order** **DESK NEW** furniture - see page 77.
- ▶ **DESK NEW** furniture cannot be ordered in colors 94, A3166, A4546, A4606 and A6766 - see page 78.

Bathroom furniture **DESK NEW** comes with ceramic counter-top washbasin in size 50 cm, with depth of 42 cm. **DESK NEW** is practical and suitable for both small and larger bathrooms. Upper cover boards - thickness 5,4 cm. Cabinets are equipped with a modern soft-close drawer system **StrongMax**. **DESK NEW** shares the side cabinets with **STORM NEW** - see page 85. For the accessories please see page 138.

- ▶ Painted towel holders **KL 45** in matt grey, white, or black color - see page 99, other holders and legs - see from page 140.
- ▶ Hidden supports for counter-top plates **KL 45 SKR**, in left or right version, **are included**.
- ▶ The cabinets are supplied fully assembled and ready for installation.

DESK NEW cabinets with ceramic counter-top washbasins

Height of the washbasins is 130 mm.

DESK NEW cabinet w. 705 mm with counter-top W/B, 1 drawer

Dimensions incl. washbasin (W x D x H): 705 x 502 x 444 mm

DE 54 70 STORM 1Z



▶ Counter-top washbasins (W x D x H) 500 x 420 x 130 mm

▶ Depth of cover board 502 mm

▶ Cabinet depth 498 mm

DESK NEW cabinet w. 905 mm with counter-top W/B, 1 drawer

Dimensions incl. washbasin (W x D x H): 905 x 502 x 444 mm

DE 54 90 L STORM 1Z



DESK NEW cabinet w. 905 mm with counter-top W/B, 1 drawer

Dimensions incl. washbasin (W x D x H): 905 x 502 x 444 mm

DE 54 90 P STORM 1Z



▶ Counter-top washbasins (W x D x H) 500 x 420 x 130 mm

DESK NEW cabinet w. 1105 mm with counter-top W/B, 1 drawer

Dimensions incl. washbasin (W x D x H): 1105 x 502 x 444 mm

DE 54 110 L STORM 1Z



DESK NEW cabinet w. 1105 mm with counter-top W/B, 1 drawer

Dimensions incl. washbasin (W x D x H): 1105 x 502 x 444 mm

DE 54 110 P STORM 1Z



▶ Hidden supports for counter-top plates are included.



DESK NEW



▶ Hidden supports for counter-top plates are included.



▶ Top plate depth 502 mm

▶ Cabinet depth 498 mm

▶ Painted towel holders KL 45 in matt grey, white, or black color - see page 99, other holders and legs - see from page 140.

DESK NEW cabinets with ceramic counter-top washbasins

Depth of the washbasins is 130 mm.

DESK NEW cabinet w. 1205 mm with counter-top W/B, 1 drawer
Dimensions incl. washbasin (W x D x H): 1205 x 502 x 444 mm
DE 54 120 L STORM 1Z



DESK NEW cabinet w. 1205 mm with counter-top W/B, 1 drawer
Dimensions incl. washbasin (W x D x H): 1205 x 502 x 444 mm
DE 54 120 P STORM 1Z



➤ Counter-top washbasins (W x D x H) 500 x 420 x 130 mm

➤ Top plate depth 502 mm

➤ Cabinet depth 498 mm

DESK NEW cabinet w. 1305 mm with counter-top W/B, 1 drawer
Dimensions incl. washbasin (W x D x H): 1305 x 502 x 444 mm
DE 54 130 L STORM 1Z



DESK NEW cabinet w. 1305 mm with counter-top W/B, 1 drawer
Dimensions incl. washbasin (W x D x H): 1305 x 502 x 444 mm
DE 54 130 P STORM 1Z



➤ Hidden supports for counter-top plates are included.

DESK NEW cabinet w. 1405 mm with counter-top W/B, 2 drawers
Dimensions incl. washbasin (W x D x H): 1405 x 502 x 444 mm
DE 54 140D STORM 2Z



Towel holders

Dimensions (W x D x H): 20 x 450 x 140 mm

KL 45 S

KL 45 B MAT

KL 45 Č MAT



➤ Suitable for towel hanging

Painted colors:
matt- grey, white, black

➤ Water outlets C/C 700 mm



IDEAL

- Information on **how to order IDEAL** furniture - see page 77.
- IDEAL comes with handles ID/G.

Bathroom furniture **IDEAL** with practical ceramic washbasins in sizes 55, 65, 75, 85, 95 and 105 cm. Depth of the basin for **ID 55** is 47 cm. The other sizes are 50 cm deep. Cabinets are equipped with a modern soft-close drawer system **StrongBox**. This classic bathroom furniture offers a big storage space. Side cabinets **UNI** start on page 108.

Accessories - see page 138.

- Recommended saving siphon **OXO D US660**, with adjustable height and depth, for furniture washbasins, to be found on page 149.

- The cabinets are supplied fully assembled and ready for installation.

IDEAL NOHA, 100 mm
(W x D x H): 54 x 54 x 100 mm
ID NOHA

- Adjustable leg



IDEAL cabinets with ceramic washbasin

Height of the washbasins is 50 mm.

IDEAL cabinet w. 550 mm with washbasin, 1 drawer, 2 doors

Dimensions incl. washbasin (W x D x H): 550 x 470 x 770 mm

ID 55 1Z 2D



IDEAL cabinet w. 650 mm with washbasin, 1 drawer, 2 doors

Dimensions incl. washbasin (W x D x H): 650 x 470 x 770 mm

ID 65 1Z 2D



IDEAL cabinet w. 750 mm with washbasin, 1 drawer, 2 doors

Dimensions incl. washbasin (W x D x H): 750 x 470 x 770 mm

ID 75 1Z 2D



IDEAL cabinet w. 850 mm with washbasin, 1 drawer, 2 doors

Dimensions incl. washbasin (W x D x H): 850 x 470 x 770 mm

ID 85 1Z 2D



IDEAL cabinet w. 950 mm with washbasin, 1 drawer, 2 doors

Dimensions incl. washbasin (W x D x H): 950 x 470 x 770 mm

ID 95 1Z 2D



IDEAL cabinet w. 1050 mm with washbasin, 1 drawer, 2 doors

Dimensions incl. washbasin (W x D x H): 1050 x 470 x 770 mm

ID 105 1Z 2D



Depth of the washbasin cabinets is 370 mm



FORTY
EOBLY





FORTY

- ▶ Information on **how to order FORTY** furniture - see page 77.
- ▶ **FORTY cannot be ordered** in colors 94, A3166, A4546, A4606 and A6766 - see page 78.

Bathroom furniture **FORTY** comes with round ceramic counter-top washbasins with diameter of 35cm and height 12 cm, in matt black color.

FORTY is practical and suitable for both small and larger bathrooms. Top plates are 5,4 cm thick. Cabinets are equipped with a modern soft-close drawer system **StrongMax**. For the accessories please see page 138.

- ▶ Hidden supports for counter-top plates are included.



- ▶ The cabinets are supplied fully assembled and ready for installation.

FORTY cabinets with ceramic counter-top washbasins

Height of the washbasins is 120 mm.

FORTY cabinet w. 650 mm with counter-top W/B, 2 drawers

Dimensions incl. washbasin (W x D x H): 655 x 502 x 745 mm

FORTY 65 ZZ



FORTY cabinet w. 650 mm with counter-top W/B, 2 drawers

Dimensions incl. washbasin (W x D x H): 655 x 502 x 865 mm

FORTY 65 ZZ N

(including legs)



➤ Counter-top washbasins (W x D x H) 350 x 350 x 120 mm

FORTY cabinet w. 1005 mm with counter-top W/B, 2 drawers

Dimensions incl. washbasin (W x D x H): 1005 x 502 x 745 mm

FORTY 100 ZZ L



FORTY cabinet w. 1005 mm with counter-top W/B, 2 drawers

Dimensions incl. washbasin (W x D x H): 1005 x 502 x 865 mm

FORTY 100 ZZ L N

(including legs)



➤ Cabinet for all versions

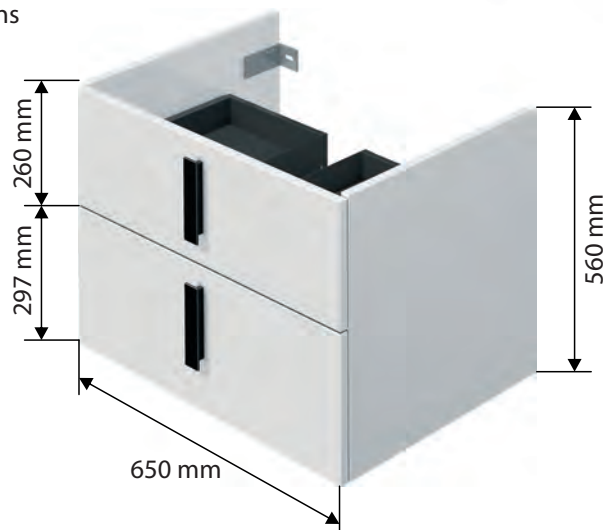

➤ Top plate thickness 54 mm

➤ Top plate depth 502 mm

➤ Cabinet depth 498 mm

FORTY cabinets with ceramic counter-top washbasins

Height of the washbasins is 120 mm.

FORTY cabinet w. 1005 mm with counter-top W/B, 2 drawers
 Dimensions incl. washbasin (W x D x H): 1005 x 502 x 745 mm
FORTY 100 2Z P



FORTY cabinet w. 1005 mm with counter-top W/B, 2 drawers
 Dimensions incl. washbasin (W x D x H): 1005 x 502 x 865 mm
FORTY 100 2Z P N
 (including legs)



➤ Counter-top washbasins (W x D x H) 350 x 350 x 120 mm

FORTY cabinet w. 1205 mm with counter-top W/B, 2 drawers
 Dimensions incl. washbasin (W x D x H): 1205 x 502 x 745 mm
FORTY 120 2Z L



FORTY cabinet w. 1205 mm with counter-top W/B, 2 drawers
 Dimensions incl. washbasin (W x D x H): 1205 x 502 x 865 mm
FORTY 120 2Z L N
 (including legs)



➤ Hidden supports for counter-top plates are included.



➤ Top plate depth 502 mm

➤ Cabinet depth 498 mm

FORTY cabinets with ceramic counter-top washbasins

Height of the washbasins is 120 mm.

FORTY cabinet w. 1205 mm with counter-top W/B, 2 drawers
Dimensions incl. washbasin (W x D x H): 1205 x 502 x 745 mm
FORTY 120 2Z P



FORTY cabinet w. 1205 mm with counter-top W/B, 2 drawers
Dimensions incl. washbasin (W x D x H): 1205 x 502 x 865 mm
FORTY 120 2Z P N
(including legs)



➤ Counter-top washbasins (W x D x H) 350 x 350 x 120 mm

FORTY side cabinets

➤ Right - hinges on the right ➤ Left - hinges on the left

FORTY high cabinet 40
2 drawers, 1 door, right
Dimensions (W x D x H):
400 x 350 x 1600 mm
FORTY SV 40 2Z 1D P



FORTY high cabinet 40
2 drawers, 1 door, left
Dimensions (W x D x H):
400 x 350 x 1600 mm
FORTY SV 40 2Z 1D L



(including legs)

➤ Right - hinges on the right ➤ Left - hinges on the left

FORTY high cabinet 40
2 drawers, 1 door, right
Dimensions (W x D x H):
400 x 350 x 1720 mm
FORTY SV 40 2Z 1D P N



(including legs)

FORTY high cabinet 40
2 drawers, 1 door, left
Dimensions (W x D x H):
400 x 350 x 1720 mm
FORTY SV 40 2Z 1D L N



➤ Adjustable glass-shelves



UNI

Universal side cabinets

Side cabinets **UNI** suitable for furniture series **KRIOS**, **RONY NEW**, **GUEST**, **BOX** and **IDEAL**. Cabinet are produced of 18mm thick wood materials. Depth of the side cabinets is 350 mm. Cabinets are equipped with a modern soft-close drawer system **StrongBox** and adjustable glass-shelves. For **KRIOS** series you can also choose separate cover boards and **ALU** shelves on page **115**. Available colors - see page **78**.

- You will find some practical accessories on page **151**.
 For example - el. double-socket **POWERBOX** is suitable for charging sonic toothbrush, etc. We also offer a portable LED lamp with sensor **LED OSVZAS**, which illuminates the interior of the furniture upon opening the doors or drawers. Very simple and fast mounting on a self-adhesive magnet. Charging via USB cable.
- The cabinets are supplied fully assembled and ready for installation.

UNI universal side cabinets

 Adjustable glass-shelves

UNI high cabinet w. 500 mm
4 doors
(W x D x H): 500 x 350 x 1618 mm
UNI SV 162/50 4D



UNI high cabinet w. 350 mm
2 doors, right
(W x D x H): 350 x 350 x 1618 mm
UNI SV 162/35 2D P



UNI high cabinet w. 350 mm
2 doors, left
(W x D x H): 350 x 350 x 1618 mm
UNI SV 162/35 2D L



 Right - hinges on the right

 Left - hinges on the left

UNI high cabinet w. 500 mm
3 doors, bin
(W x D x H): 500 x 350 x 1618 mm
UNI SV 162/50 2D K



UNI high cabinet w. 350 mm
2 doors, bin, right
(W x D x H): 350 x 350 x 1618 mm
UNI SV 162/35 2D KP



UNI high cabinet w. 350 mm
2 doors, bin, left
(W x D x H): 350 x 350 x 1618 mm
UNI SV 162/35 2D KL



 Removable laundry bin

 Right - hinges on the right

 Left - hinges on the left

UNI universal side cabinets

 Adjustable glass-shelves

UNI high cabinet w. 500 mm
2 doors
(W x D x H): 500 x 350 x 1618 mm
UNI SV 162/50 2D



UNI high cabinet w. 350 mm
1 drawer, 2 doors, right
(W x D x H): 350 x 350 x 1618 mm
UNI SV 162/35 1Z 2D P



UNI high cabinet w. 350 mm
1 drawer, 2 doors, left
(W x D x H): 350 x 350 x 1618 mm
UNI SV 162/35 1Z 2D L



 Right - hinges on the right

 Left - hinges on the left

UNI high cabinet w. 500 mm
1 drawer, 3 doors, bin
(W x D x H): 500 x 350 x 1618 mm
UNI SV 162/50 1Z 2D K



UNI high cabinet w. 350 mm
1 drawer, 2 doors, bin, right
(W x D x H): 350 x 350 x 1618 mm
UNI SV 162/35 1Z 2D KP



UNI high cabinet w. 350 mm
1 drawer, 2 doors, bin, left
(W x D x H): 350 x 350 x 1618 mm
UNI SV 162/35 1Z 2D KL



 Removable laundry bin

 Right - hinges on the right

 Left - hinges on the left

UNI universal side cabinets

 Adjustable glass-shelves

UNI high cabinet w. 500 mm
1 drawer, 4 doors
(W x D x H): 500 x 350 x 1618 mm
UNI SV 162/50 1Z 4D



UNI high cabinet w. 350 mm
1 door, right
(W x D x H): 350 x 350 x 1618 mm
UNI SV 162/35 1D P



UNI high cabinet w. 350 mm
1 door, left
(W x D x H): 350 x 350 x 1618 mm
UNI SV 162/35 1D L



 Right - hinges on the right

 Left - hinges on the left

UNI high cabinet w. 500 mm
4 doors, open shelf
(W x D x H): 500 x 350 x 1618 mm
UNI SV 162/50 4D OP



UNI high cabinet w. 350 mm
2 doors, open shelf, right
(W x D x H): 350 x 350 x 1618 mm
UNI SV 162/35 2D OP P



UNI high cabinet w. 350 mm
2 doors, open shelf, left
(W x D x H): 350 x 350 x 1618 mm
UNI SV 162/35 2D OP L



 Right - hinges on the right

 Left - hinges on the left

UNI universal side cabinets

 Adjustable glass-shelves

UNI medium cabinet w. 500 mm
2 doors
(W x D x H): 500 x 350 x 1218 mm
UNI SS 122/50 2D



UNI medium cabinet w. 350 mm
2 doors, right
(W x D x H): 350 x 350 x 1218 mm
UNI SS 122/35 2D P



UNI medium cabinet w. 350 mm
2 doors, left
(W x D x H): 350 x 350 x 1218 mm
UNI SS 122/35 2D L



 Right - hinges on the right

 Left - hinges on the left

UNI medium cabinet w. 500 mm
4 doors
(W x D x H): 500 x 350 x 1218 mm
UNI SS 122/50 4D



UNI medium cabinet w. 350 mm
2 doors, bin, right
(W x D x H): 350 x 350 x 1218 mm
UNI SS 122/35 2D K P



UNI medium cabinet w. 350 mm
2 doors, bin, left
(W x D x H): 350 x 350 x 1218 mm
UNI SS 122/35 2D K L



 Right - hinges on the right

 Left - hinges on the left

 Removable laundry bin

 Removable laundry bin

UNI universal side cabinets

 Adjustable glass-shelves

UNI medium cabinet w. 500 mm
2 doors, bin
(W x D x H): 500 x 350 x 1218 mm
UNI SS 122/50 2D K



 Removable laundry bin

UNI medium cabinet w. 350 mm
1 door, right
(W x D x H): 350 x 350 x 1218 mm
UNI SS 122/35 1D P



 Right - hinges on the right

UNI medium cabinet w. 350 mm
1 door, left
(W x D x H): 350 x 350 x 1218 mm
UNI SS 122/35 1D L



 Left - hinges on the left

UNI medium cabinet w. 500 mm
1 drawer, 4 doors
(W x D x H): 500 x 350 x 1218 mm
UNI SS 122/50 1Z 4D



UNI medium cabinet w. 350 mm
1 drawer, 2 doors, right
(W x D x H): 350 x 350 x 1218 mm
UNI SS 122/35 1Z 2D P



 Right - hinges on the right

UNI medium cabinet w. 350 mm
1 drawer, 2 doors, left
(W x D x H): 350 x 350 x 1218 mm
UNI SS 122/35 1Z 2D L



 Left - hinges on the left

UNI universal side cabinets

 Adjustable glass-shelves

UNI medium cabinet w. 500 mm
4 doors, open shelf
(W x D x H): 500 x 350 x 1218 mm
UNI SS 122/50 4D OP



UNI medium cabinet w. 350 mm
2 doors, open shelf, right
(W x D x H): 350 x 350 x 1218 mm
UNI SS 122/35 2D OP P



UNI medium cabinet w. 350 mm
2 doors, open shelf, left
(W x D x H): 350 x 350 x 1218 mm
UNI SS 122/35 2D OP L



 Right - hinges on the right

 Left - hinges on the left

UNI low cabinet w. 500 mm,
2 doors
(W x D x H): 500 x 350 x 818 mm
UNI SN 82/50 2D



UNI low cabinet w. 350 mm
1 door, right / left / bin
(W x D x H): 350 x 350 x 818 mm
UNI SN 82/35 1D P



 P - hinges on the right

UNI SN 82/35 1D L

 L - hinges on the left

UNI SN 82/35 1D K

 Laundry bin

UNI low cabinet w. 350 mm
1 drawer, 1 door, right / left / bin
(W x D x H): 350 x 350 x 818 mm
UNI SN 82/35 1Z 1D P



 P - hinges on the right

UNI SN 82/35 1Z 1D L

 L - hinges on the left

UNI SN 82/35 1Z K

 Laundry bin

UNI low cabinet w. 500 mm
1 door, bin
(W x D x H): 500 x 350 x 818 mm
UNI SN 82/50 K



UNI low cabinet w. 500 mm
1 drawer, 1 door, bin
(W x D x H): 500 x 350 x 818 mm
UNI SN 82/50 1Z K



UNI low cabinet w. 500 mm
1 drawer, 2 doors
(W x D x H): 500 x 350 x 818 mm
UNI SN 82/50 1Z 2D



UNI universal side cabinets

 Adjustable wooden-shelves

UNI high cabinet w. 800 mm
2 drawers, 4 doors
(W x D x H): 800 x 350 x 1618 mm
UNI SV 162/80 2Z 4D



 HETTICH WingLine
Folding doors system



 Adjustable glass-shelves

UNI upper cabinet w. 500 mm
2 doors
(W x D x H): 500 x 230 x 598 mm
UNI HZ 60/50 2D



UNI upper cabinet w. 350 mm
1 door, right / left
(W x D x H): 350 x 230 x 598 mm
UNI HZ 60/35 1D P

 P - hinges on the right
UNI HZ 60/35 1D L

 L - hinges on the left



 Optional accessories for side cabinets UNI to KRIOS series



ALU shelf w. 500 mm, black base-plate
(W x D x H): 500 x 350 x 220 mm
OALU 50/22 B



ALU shelf w. 350 mm, black base-plate
(W x D x H): 350 x 350 x 220 mm
OALU 35/22 B



ALU shelf w. 500 mm, white base-plate
(W x D x H): 500 x 350 x 220 mm
OALU 50/22 BW



ALU shelf w. 350 mm, white base-plate
(W x D x H): 350 x 350 x 220 mm
OALU 35/22 BW



Compact cover board w. 500 mm, black
(W x D x H): 500 x 350 x 12 mm
UNI KD COMPACT 50 B

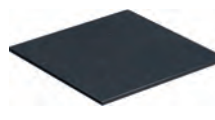

Compact cover board w. 350 mm, black
(W x D x H): 350 x 350 x 12 mm
UNI KD COMPACT 35 B



Compact cover board w. 500 mm, white
(W x D x H): 500 x 350 x 10 mm
UNI KD COMPACT 50 W



Compact cover board w. 350 mm, white
(W x D x H): 350 x 350 x 10 mm
UNI KD COMPACT 35 W

 For the Krios series please choose the UNI side cabinets in color A3416



E.g.	Furniture code <i>UNI SV 162/35 2D P</i>	Color A3416	Handle PU
------	---	----------------	--------------



UNI
UNI

UNI universal side cabinets

UNI high cabinet w. 650 mm
2 doors, open shelf
(W x D x H): 646 x 350 x 1900 mm
UNI SV 190/65 2D OP

-  Adjustable glass-shelves
-  Adjustable wooden-shelf
-  Space for the washing machine

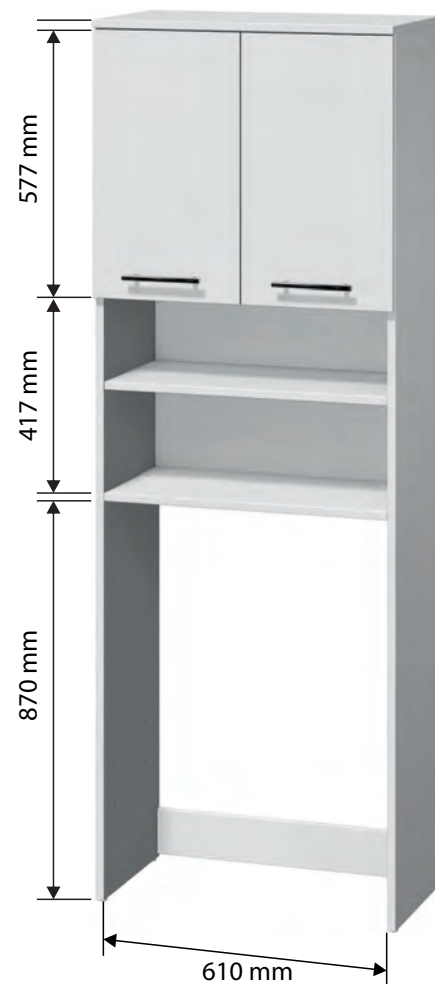

-  Removable laundry bin

Removable laundry bin w. 290 mm
for cabinets of width 350 mm
(W x D x H): 290 x 290 x 520 mm
KOŠ Š. 29 CM



Removable laundry bin w. 440 mm
for cabinets of width 500 mm
(W x D x H): 440 x 440 x 520 mm
KOŠ Š. 44 CM



Mirrors and mirror cabinets

Mirrors and mirror cabinets suitable for all series in the catalogue

You can choose from a wide range of mirrors and mirror cabinets with SQ (super quality) **LED** lighting, or without lighting. Mirror cabinets are equipped with el. socket and switch **BERKER**.

IP protection class: **IP44**

Energy class: **B - G**

Additional lamps to be found on page **136 - 137**.

Highest quality silver-coated mirror-glass (corrosion resistant). Adjustable glass-shelves inside the mirror cabinets.

Positioning of the el. socket and switch (el. double-socket) on INTEDOOR mirror cabinets. (Except of R ZS and PIR ZS)

 Colors available for corpuses on mirror cabinets

 LETTY - on page 09

 TARA - on page 27

 KRIOS - on page 39

 OXO MULTI - on page 47

 BRAVE - on page 71

 STORM NEW - on page 78

 DESK NEW - on page 78

 IDEAL - on page 78

 FORTY - on page 78

 UNI - on page 78

230V / 50 Hz
I = 10 A max.
IP 44 CE



B.
Berker

Detail - El. socket + switch **BERKER** placed outside, on the bottom side of corpus.

Comparison with power-box placed inside

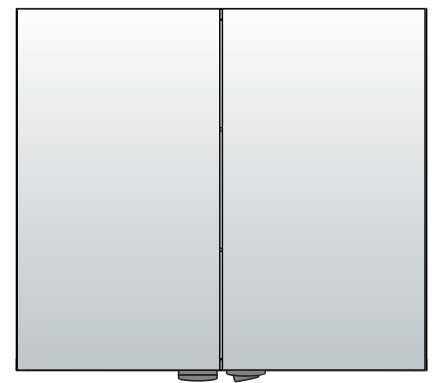
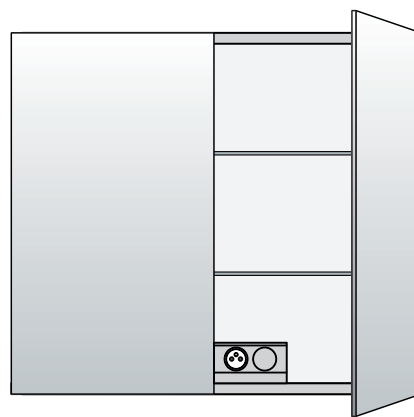

Do you need to open the mirror door to switch the light on?

YES 

NO 

Do you have to keep the mirror door slightly open while using an el. device (hair dryer, hair straightener, shaver, etc.) ?

YES 

NO 

Does electric equipment take much storage space inside the cabinet?

YES 

NO 

Mirrors

AL ZS

➤ Mirrors in the aluminium frame, can be supplied with vertical installation upon request



➤ Silver elox-anodized

➤ Depth of mirrors 22 mm

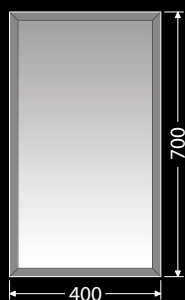

AL ZS 40



AL ZS 50

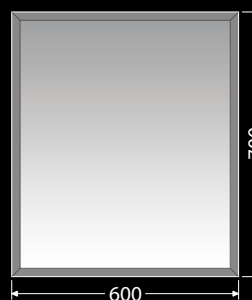

AL ZS 60

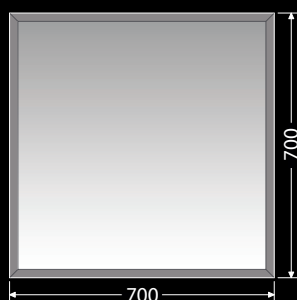

AL ZS 70

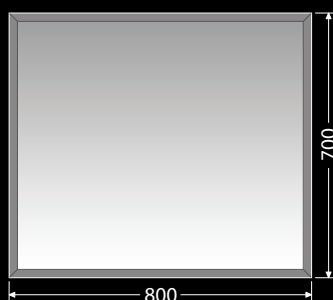

AL ZS 80



AL ZS 90



AL ZS 100







AL ZS 120

Mirrors

LI4 ZS

Mirrors with integrated cold color LED lighting (2x 7,5W/12V) + heating foil



-  Depth of mirrors 30mm
-  LED - cold light color
-  IR sensor
-  Energy class B

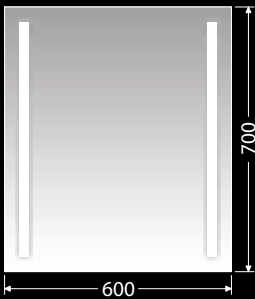

LI4 ZS 60/70 TF

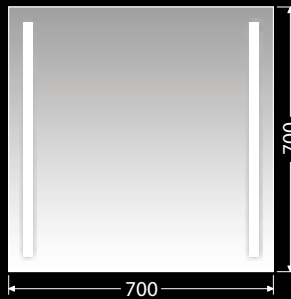

LI4 ZS 70/70 TF

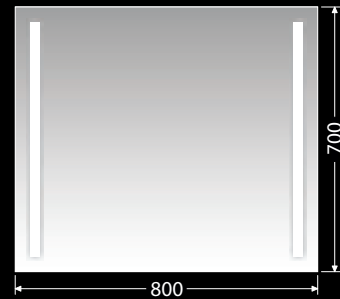

LI4 ZS 80/70 TF

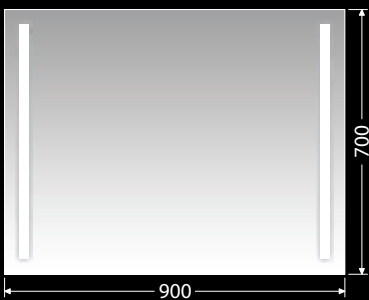

LI4 ZS 90/70 TF

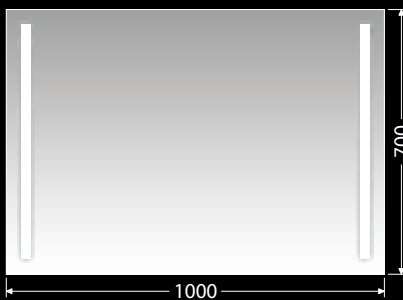

LI4 ZS 100/70 TF

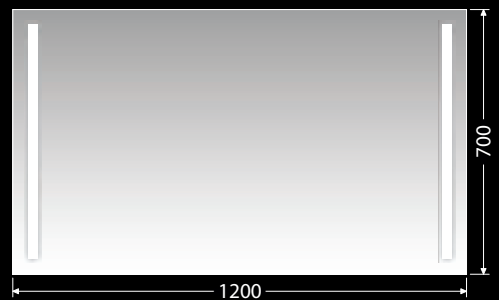

LI4 ZS 120/70 TF

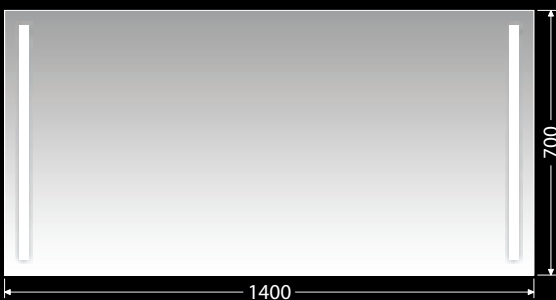





LI4 ZS 140/70 TF

IP 44

WA5

Mirrors with integrated cold color LED lighting (18 - 32 W/12V) + heating foil



-  Depth of mirrors 30mm
-  LED - cold light color
-  IR sensor
-  Energy class B

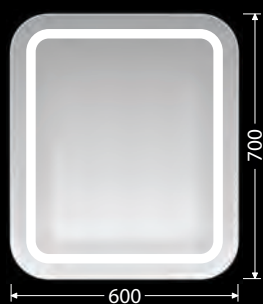

WA5 ZS 60/70 TF

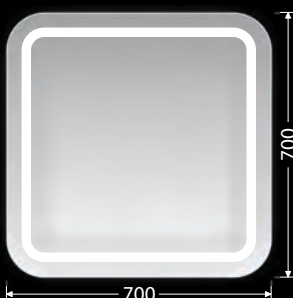

WA5 ZS 70/70 TF



WA5 ZS 80/70 TF

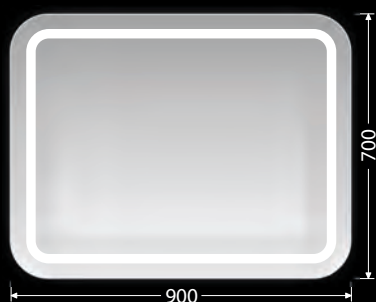

WA5 ZS 90/70 TF

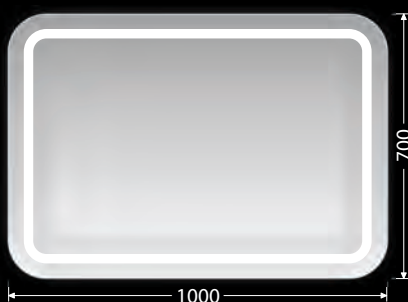

WA5 ZS 100/70 TF

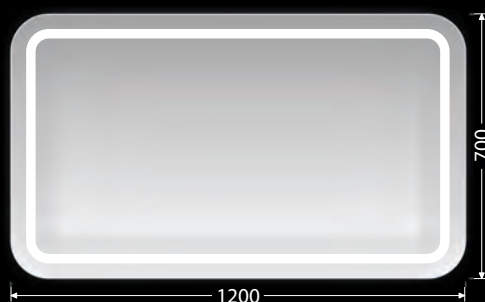

WA5 ZS 120/70 TF

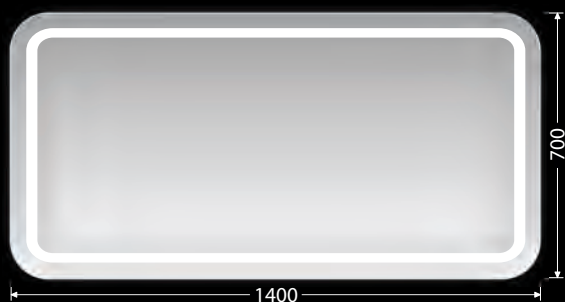

WA5 ZS 140/70 TF

IP 44

Mirrors

AUSTIN

Bathroom mirror with LED illuminated backside, cold colored LED lighting (25- 40W/12V)



 LED illuminated backside

 Depth of mirrors 45 mm

 LED - cold light color

 Energy class B

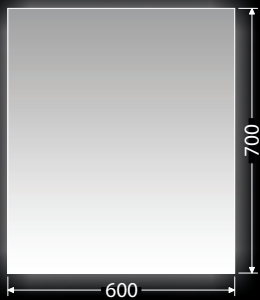

AU ZS 60



AU ZS 80



AU ZS 100

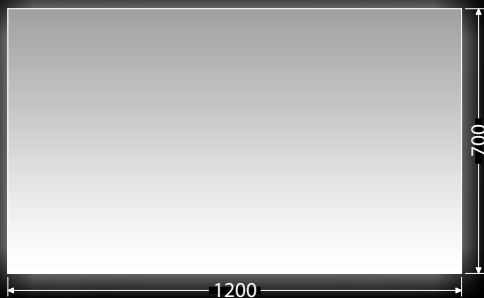

AU ZS 120



AU ZS 140

IP 44



CENTINO

Bathroom mirror with LED illuminated aluminium frame, cold colored LED lighting (25- 40W/12V)

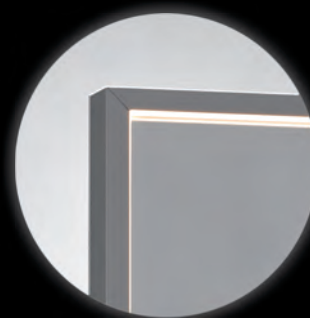

 Detail - frame illuminated on the inside



-  Depth of mirrors 40 mm
-  LED - cold light color
-  Energy class B



CE ZS 60 S
CE ZS 60 B

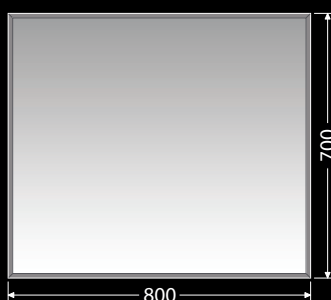

CE ZS 80 S
CE ZS 80 B

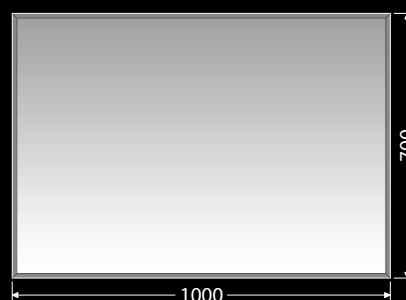

CE ZS 100 S
CE ZS 100 B



CE ZS 120 S
CE ZS 120 B



CE ZS 140 S
CE ZS 140 B

 Colors of the frame

BLACK

B

SILVER

S

IP 44

Mirrors

PINETO

LED illuminated bathroom mirror in aluminium frame, cold colored LED lighting (12- 28W/12V)



 Detail of the illumination



 Depth of mirrors 40 mm

 LED - color light color

 Energy class F

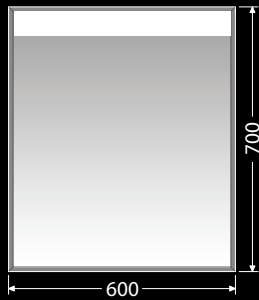

PI ZS 60 S
PI ZS 60 B

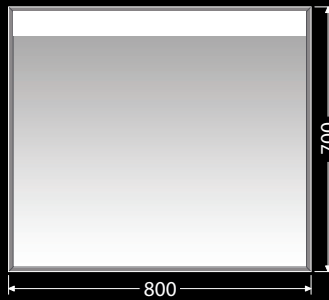

PI ZS 80 S
PI ZS 80 B

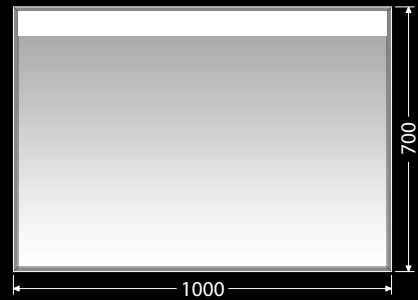

PI ZS 100 S
PI ZS 100 B



PI ZS 120 S
PI ZS 120 B



PI ZS 140 S
PI ZS 140 B

 Colors of the frame

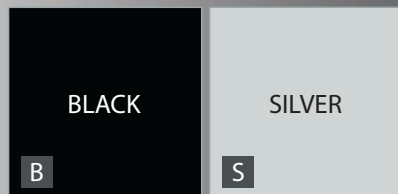

Mirrors with integrated cold color LED lighting (18 - 32 W/12V)



ROUND



ELIPSE



 + Heating foil

 Depth of mirrors 30 mm
 cold-colored LED lighting
 Energy class B

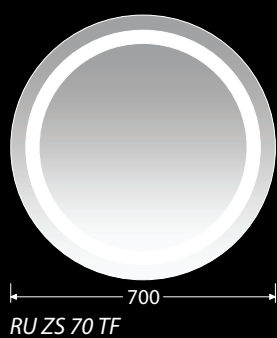
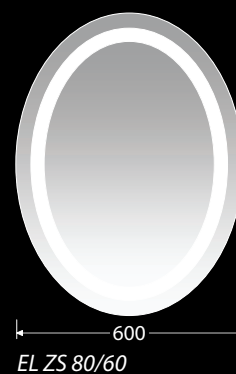
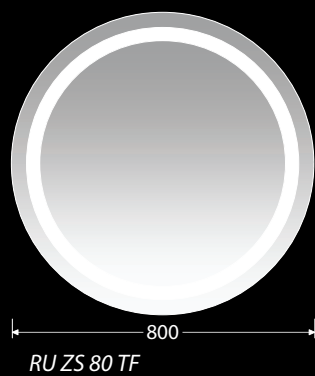
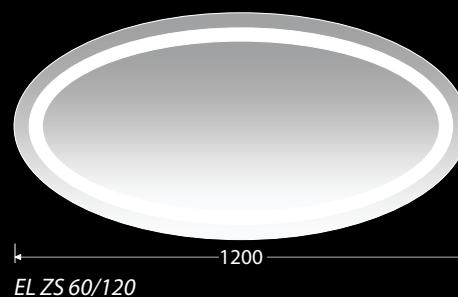
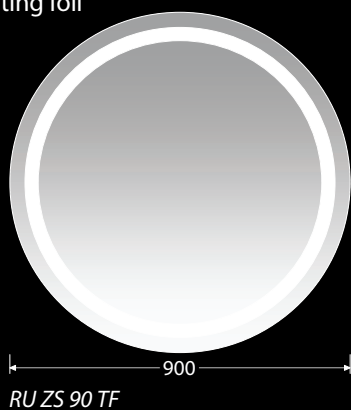





IP 44

Mirrors

MAJESTIC



 LED illuminated bathroom mirror in aluminium frame, cold colored LED lighting (12- 28W/12V)

-  Depth of mirrors 30 mm
-  LED - cold light color
-  Energy class B

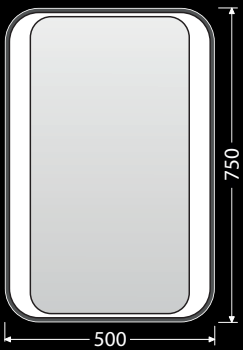
 Without LED lighting



MA ZS 50 B LED

-  LED - cold light
-  Matt black frame



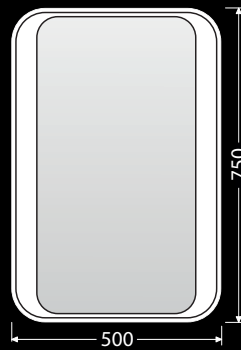

MA ZS 50 B

-  Matt black frame



MA ZS 50 W LED

-  LED - cold light
-  Matt white frame

 Without LED lighting



MA ZS 50 W

-  Matt white frame

 Colors of the frame

BLACK

B

WHITE

W

IP 44

MAJESTIC

LED illuminated bathroom mirror in aluminium frame, cold colored LED lighting (12- 28W/12V)



MA ZS 60 B LED

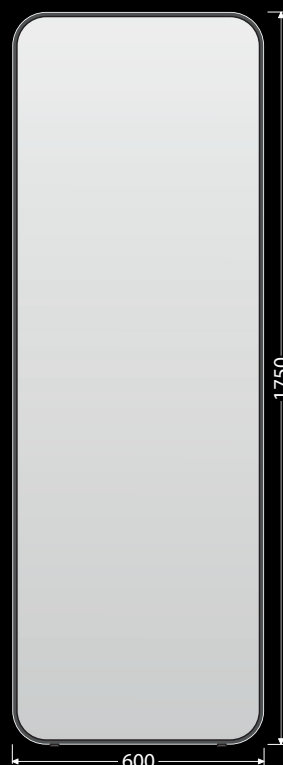

MA ZS 60 B

LED - cold light
 Matt black frame
 Without LED lighting

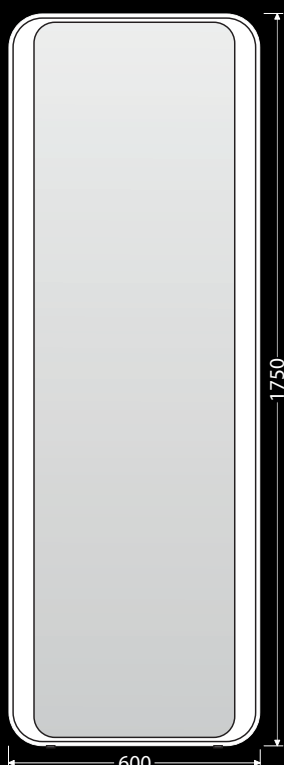

MA ZS 60 W LED

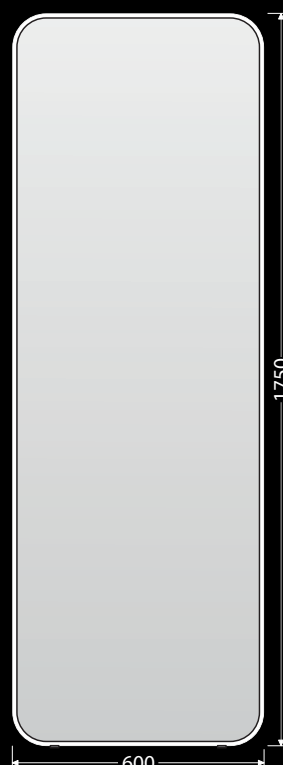

MA ZS 60 W

Colors of the frame

LED - cold light
 Matt white frame
 Without LED lighting



Mirror cabinets

NY ZS Mirror cabinets



▶ El. socket + switch BERKER



⬆ El. socket + switch BERKER placed outside, on the bottom side of the mirror cabinets NY ZS, E ZS and D ZS

▶ Adjustable glass-shelves

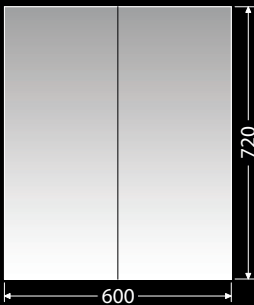

NY ZS 60

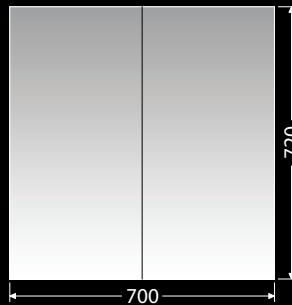

NY ZS 70

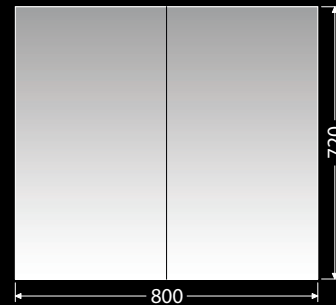

NY ZS 80

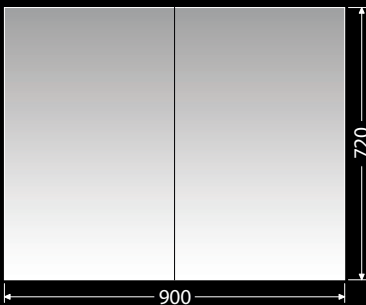

NY ZS 90

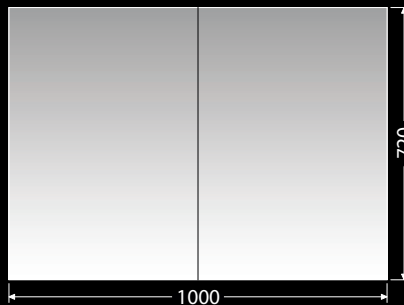

NY ZS 100

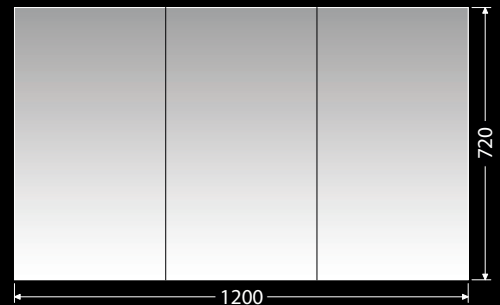

NY ZS 120 3Dv

▶ Wooden doors with 4mm thick mirror

▶ Depth of mirror cabinets 140 mm

⬆ 2x (el. socket & switch)

IP 44

E ZS Mirror cabinets



 Adjustable glass-shelves

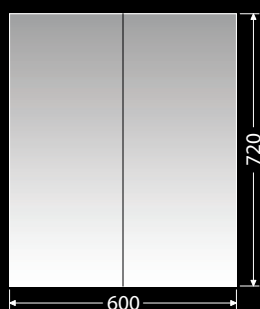

E ZS 60

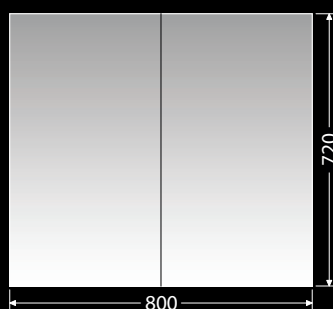

E ZS 80

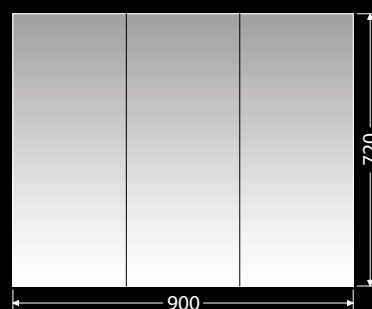

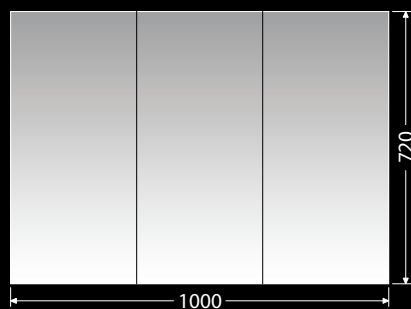

E ZS 90

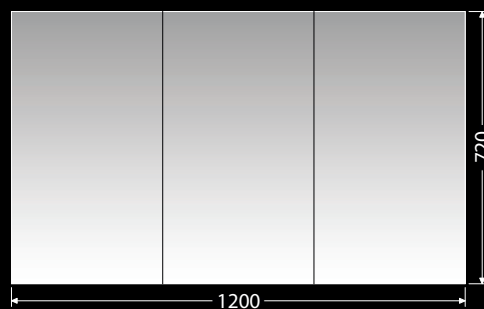

E ZS 100



E ZS 120

-  El. socket + switch BERKER
-  Doors - double-sided mirror 6 mm
-  Depth of the mirror cabinets 130 mm

 2x (el. socket + switch)

IP 44

Mirror cabinets

D ZS

Mirror cabinets with integrated cold color LED lighting (12,2W/m, 12V)



Adjustable glass-shelves

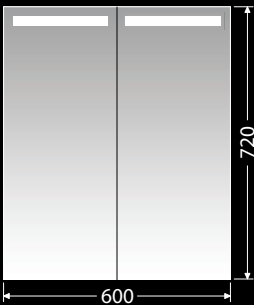

D ZS 60

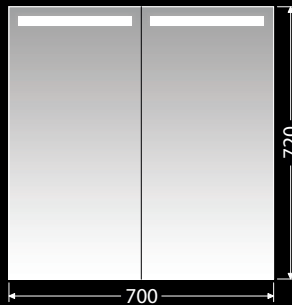

D ZS 70

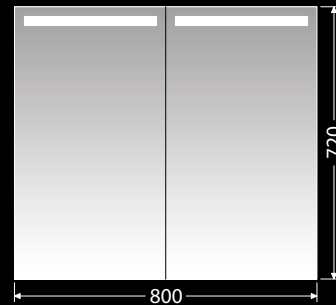

D ZS 80

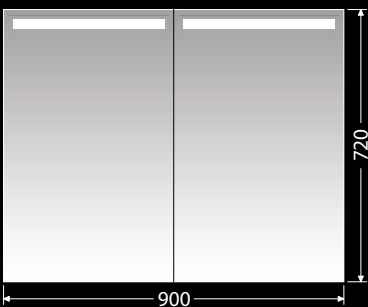

D ZS 90

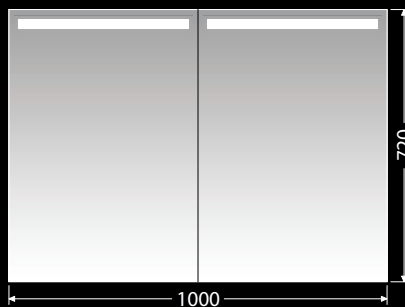

D ZS 100

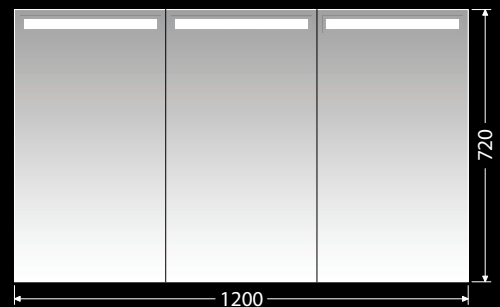

D ZS 120

- ▶ El. socket + switch BERKER
- ▶ Doors - mirror 4 mm
- ▶ Depth of the mirror cabinets 140 mm
- ▶ LED - cold light color
- ▶ Energy class B

▶ D ZS 120 has an el. socket + switch on the right bottom side and an el. socket on the left side.

IP 44

Mirror cabinets

R ZS

Mirror cabinets with integrated warm color LED lighting (18W/m, 24V)



Adjustable glass-shelves

El. socket + switch BERKER

- Detail - el. socket + switch
- Depth of the mirror cabinets 140 mm
- LED - warm light color
- Energy class E

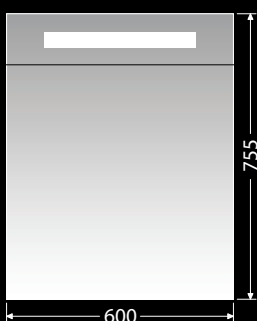

R ZS 60 L LED
R ZS 60 P LED

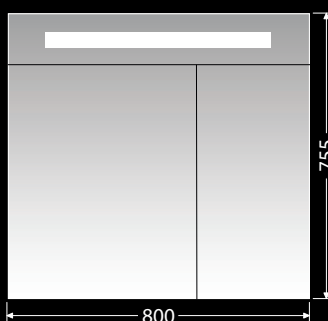

R ZS 80 LED

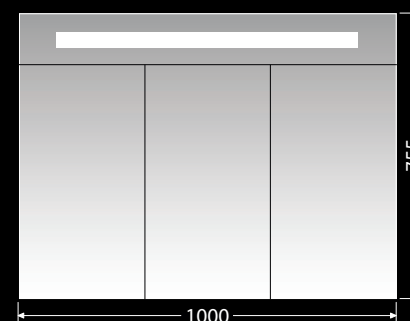

R ZS 100 LED

L - hinges on the left side

P - hinges on the right side

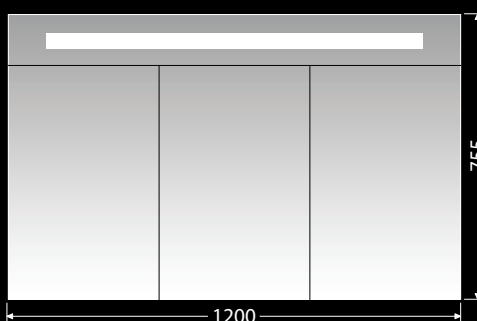

R ZS 120 LED

El. sockets + switches BERKER are placed inside R ZS

Doors - double-sided mirror 6 mm



Mirror cabinets

PIR ZS

Mirror cabinets with integrated warm color LED lighting (18W/m, 24V)



Detail - el. socket + switch BERKER placed inside R ZS and PIR ZS

Adjustable glass-shelves

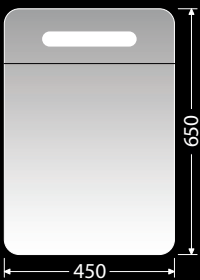

PIR ZS 45 L LED

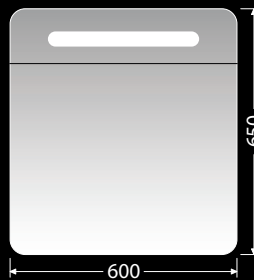

PIR ZS 60 L LED

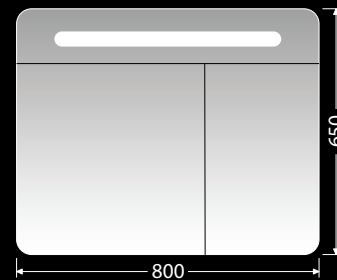

PIR ZS 80 L LED

L - hinges on the left side

L - hinges on the left side

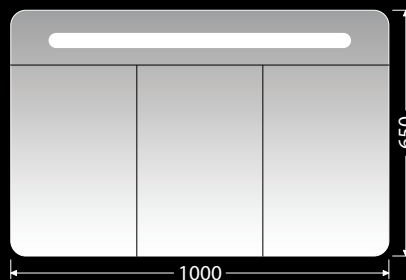

PIR ZS 100 LED

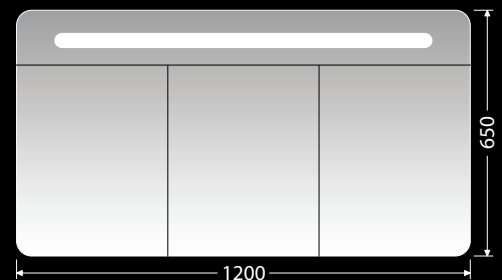

PIR ZS 120 LED

El. sockets + switches BERKER are placed inside PIR ZS

- ▶ El. socket + switch BERKER
- ▶ Doors - double-sided mirror 6 mm
- ▶ Depth of the mirror cabinets 140 mm
- ▶ LED - warm light color
- ▶ Energy class E

IP 44

Mirror cabinets

TONIC ZS Mirror cabinets with integrated cold color LED lighting (18W/m, 24V)



Integrated LED lighting

- El. socket + switch BERKER
- Doors - double-sided mirror 6 mm
- Depth of the mirror cabinets 140 mm
- LED - cold light color
- Energy class F

Adjustable glass-shelves

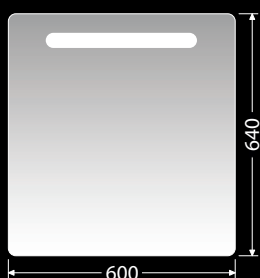

TONIC ZS 60 L

Rounded corners

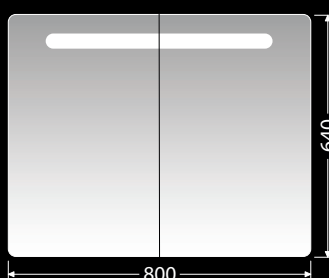

TONIC ZS

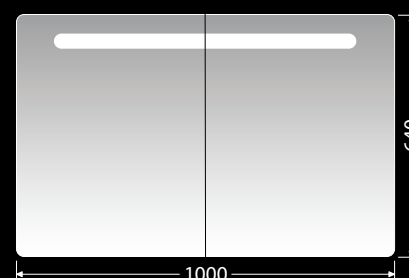

TONIC ZS 100

L - hinges on the left side

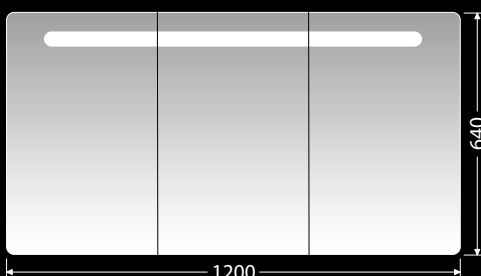

TONIC ZS 120

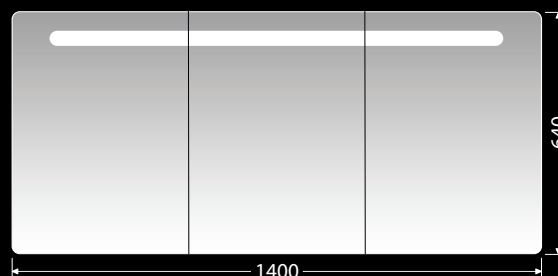

TONIC ZS 140



El. socket + switch BERKER is placed outside, on the bottom side of the mirror cabinets TONIC



Mirror cabinets

TONIC H ZS Mirror cabinets with integrated cold color LED lighting (18W/m, 24V)



- ▶ El. socket + switch BERKER
- ▶ Doors - double-sided mirror 6 mm
- ▶ Depth of the mirror cabinets 140 mm
- ▶ LED - cold light color
- ▶ Energy class F

▶ Adjustable glass-shelves

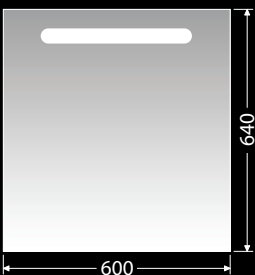

TONIC H ZS 60 L

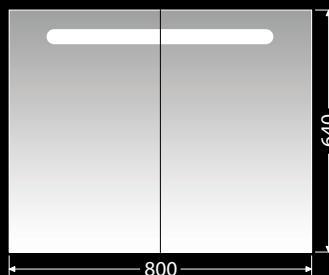

TONIC H ZS 80

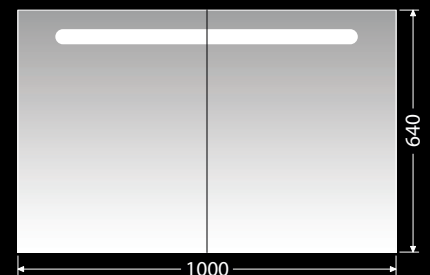

TONIC H ZS 100

▶ L - hinges on the left side

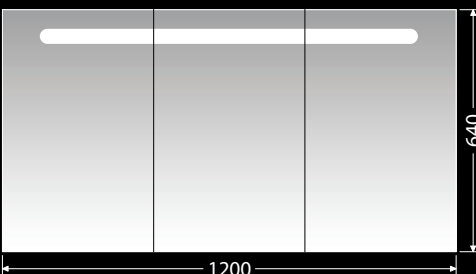

TONIC H ZS 120

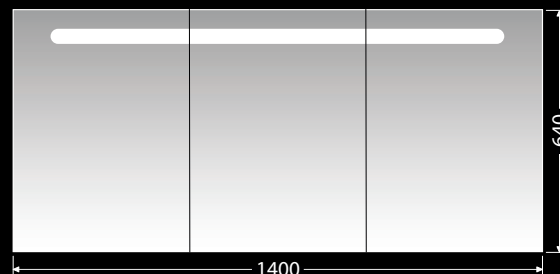

TONIC H ZS 140



- ▶ El. socket + switch BERKER is placed outside, on the bottom side of the mirror cabinets TONIC

IP 44

Mirror cabinets

OMP ZS Mirror cabinets to OXO Multi series



El. socket + switch BERKER is placed outside the mirror cabinets OMP ZS

Adjustable glass-shelves

- El. socket + switch BERKER
- Doors - double-sided mirror 6 mm
- Depth of the mirror cabinets 145 mm
- Available colors on page 47

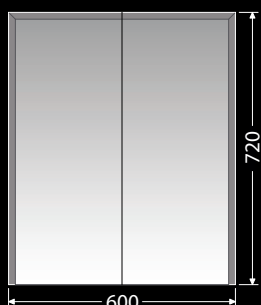

OMP ZS 60

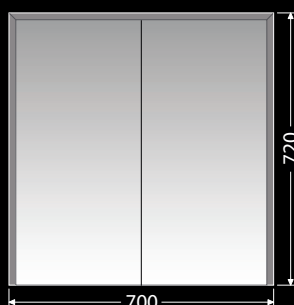

OMP ZS 70

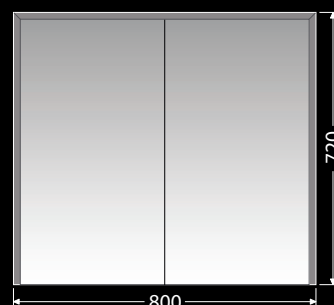

OMP ZS 80

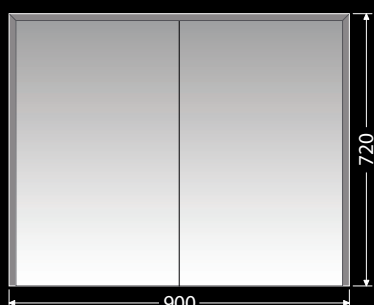

OMP ZS 90

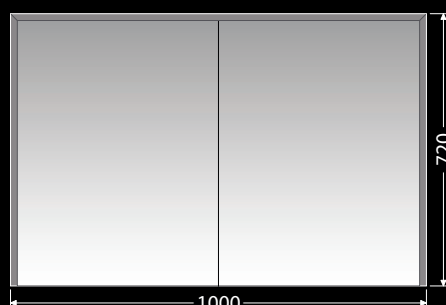

OMP ZS 100

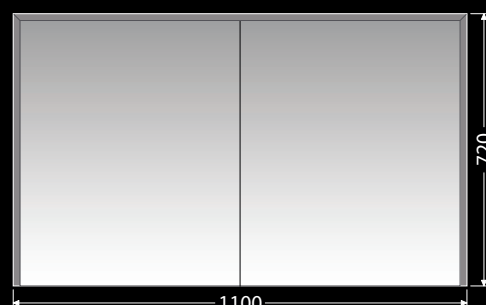

OMP ZS 110

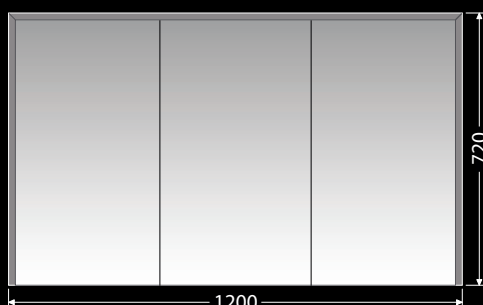

OMP ZS 120 3D

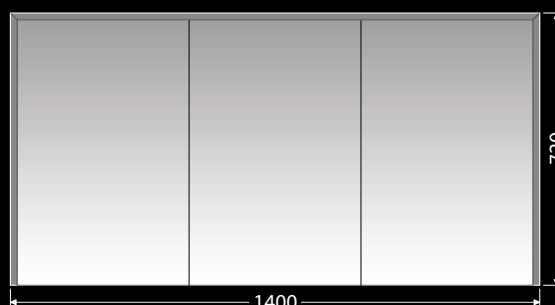

OMP ZS 140 3D

IP 44

Lamps for the mirrors and mirror cabinets



DITA 45

LED - day light color
6 W, IP44 230 V AC
Chrome / white
Energy class E
w. 450 mm



BEKA 30

LED - day light color
5 W, IP44, 230 V AC
Chrome / white
Energy class E
w. 300 mm



Lamps including IP54 clamp



BEKA 60

LED - day light color
9 W, IP44, 230 V AC
Chrome / white
Energy class E
w. 600 mm



**AKRA 30**

LED 4000 - 4500 K
 5 W, IP44 , 230 V AC
 Chrome / white
 Energy class E
 w. 300 mm

**AKRA 50**

LED 4000 - 4500 K
 9 W, IP44, 230V AC
 Chrome / white
 Energy class E
 w. 500 mm



 Lamps including IP54 clamp



ACCESSORIES

Drawer trays / organizers

Standard color: white

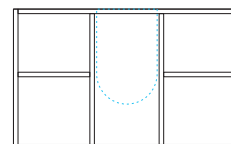

PR K1
For drawers w. 550 - 650 mm

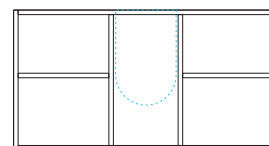

PR K2
For drawers w. 700 - 850 mm

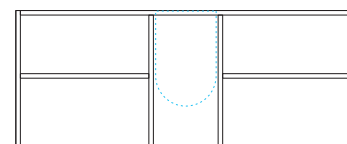

PR K3
For drawers w. 900 - 1100 mm

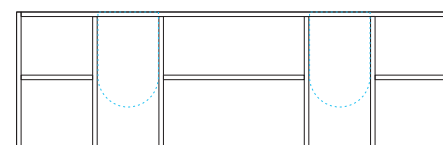

PR K4
For drawers w. 1150 - 1200 mm

How to order an organizer.

- 1) Choose a cabinet with drawer(s) (Furniture code).
- 2) Select the organizer **PR K** and the number of desired pieces.
- 3) Indicate if it's for upper or lower drawer.

E.g.	Furniture code OXO MULTI OALU 140D 2Z KDP	Organizer code PR K2/2ks
------	--	-----------------------------





Furniture legs and supports

Furniture legs make it easier to install bathroom furniture where it is not possible to hang the cabinets firmly and securely on the wall. For example, in case of walls made of different kinds of gypsum plasterboards. We offer legs for both washbasin cabinets and side cabinets.

Consoles (supports) serve as supporting elements for the top plates under the counter-top washbasins. At the same time, these supports can be used to hang towels and bath towels.

 Hidden consoles (supports) for the washbasin plates are automatically included for series DESK NEW a FORTY.



Furniture legs

LUXE leg, height 16 cm, matt white
Adjustable
LUXENOHA16BM



LUXE leg, height 16 cm, matt black
Adjustable
LUXENOHA16CM



 *LE DESK 60 2Z*



LUXE leg, height 24 cm, matt white
Adjustable
LUXENOHA24BM



LUXE leg, height 24 cm, matt black
Adjustable
LUXENOHA24CM



 *STORM NEW 75 2Z*



LUXE leg, height 26,6 cm, matt white
Adjustable
LUXENOHA26,6BM



LUXE leg, height 26,6 cm, matt black
Adjustable
LUXENOHA26,6CM



 *BOX ELITE 60 2Z*

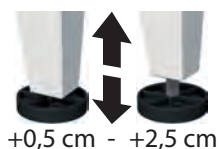

 Adjustability

 16cm legs can be used for example for furniture LETTY 3Z, LETTY DESK 2Z, BRAVE DESK and all side cabinets.

 24 cm legs for STORM NEW and all side cabinets.

 26,6 cm legs for BOX ARTE, BOX ELITE, LETTY 2Z, BRAVE and all side cabinets.

Furniture legs

LUXE leg, height 39,2 cm, matt white
Adjustable
LUXENOHA39,2BM

LUXE leg, height 39,2 cm, matt black
Adjustable
LUXENOHA39,2CM

 *GUEST 40 L*

 *GUEST 40 L T*



 39,2 cm legs can be used for example for furniture GUEST

+0,5 cm - +2,5 cm

 Adjustability

Rectangle leg, height 12 cm, matt white
Dimensions (W x D x H): 30 x 330 x 120 mm
N 33 S3 B MAT

Rectangle leg, height 12 cm, matt black
Dimensions (W x D x H): 30 x 330 x 120 mm
N 33 S3 Č MAT



Rounded rectangle leg, height 12 cm,
matt white
Dimensions (W x D x H): 40 x 330 x 120 mm
N 33 R3 B MAT

Rounded rectangle leg, height 12 cm,
matt black
Dimensions (W x D x H): 40 x 330 x 120 mm
N 33 R3 Č MAT



 Painted colors: matt white, matt black

 Legs *N 33 S3* and *N 33 R3* can be used for side cabinets

Furniture legs

Rectangle leg, height 12 cm, matt white
Dimensions (W x D x H): 30 x 450 x 120 mm
N 45 S3 B MAT



Rectangle leg, height 12 cm, matt black
Dimensions (W x D x H): 30 x 450 x 120 mm
N 45 S3 Č MAT



Rounded rectangle leg, height 12 cm, matt white
Dimensions (W x D x H): 40 x 450 x 120 mm
N 45 R3 B MAT



Rounded rectangle leg, height 12 cm, matt black
Dimensions (W x D x H): 40 x 450 x 120 mm
N 45 R3 Č MAT





IDEAL leg, height 10 cm, chrome
Dimensions (W x D x H): 54 x 54 x 100 mm
ID NOHA



 Adjustable leg



 Legs *N 45 S3* a *N 45 R3* are suitable for use with cabinets FORTY

 Legs *ID NOHA* are suitable for series IDEAL and all side cabinets.

Furniture legs

Rectangle leg, matt white
(W x D x H): 30 x 450 x 680 mm
N 45V S3 B MAT



Rectangle leg, matt black
(W x D x H): 30 x 450 x 680 mm
N 45V S3 Č MAT



Rounded rectangle leg, matt white
(W x D x H): 40 x 330 x 680 mm
N 45V R3 B MAT



Rounded rectangle leg, matt black
(W x D x H): 40 x 330 x 680 mm
N 45V R3 Č MAT



Legs *N 45V S3* and *N 45V R3* are suitable for use with cabinets FORTY and DESK NEW

Furniture legs

Wooden leg, height 15 cm, beech wood

Dimensions: Height 150 mm, upper diameter 48 mm, bottom 25 mm

BUKNOHA15



Fixation plate
galvanized

Wooden leg, height 20 cm, beech wood

Dimensions: Height 200 mm, upper diameter 48 mm, bottom 25 mm

BUKNOHA20



Fixation plate
galvanized

Wooden leg, height 25 cm, beech wood

Dimensions: Height 250 mm, upper diameter 48 mm, bottom 25 mm

BUKNOHA25



Fixation plate
galvanized



 Wooden legs **BUKNOHA15** are suitable for cabinets OXO MULTI 2Z - 4Z and all side cabinets

 Wooden legs **BUKNOHA20** are suitable for STORM NEW and all side cabinets

 Wooden legs **BUKNOHA25** are suitable for LETTY 2Z and all side cabinets

Supports for plates

Consoles for plates under the counter-top washbasins.

Rectangle console, 45 cm, matt white
(W x D x H): 30 x 450 x 140 mm
KL 45 S3 B MAT



Rectangle console, 45 cm, matt black
(W x D x H): 30 x 450 x 140 mm
KL 45 S3 Č MAT



Hidden console, 40 cm, left, matt grey
(W x D x H): 100 x 400 x 100 mm
KONZOLE 40 SKR L



 Adjustable console

Rounded console, 45 cm, matt white
(W x D x H): 40 x 450 x 140 mm
KL 45 R3 B MAT



Rounded console, 45 cm, matt black
(W x D x H): 40 x 450 x 140 mm
KL 45 R3 Č MAT



Hidden console, 40 cm, right, matt grey
(W x D x H): 100 x 400 x 100 mm
KONZOLE 40 SKR P



 Adjustable console

Rectangle console, 45 cm, matt white
(W x D x H): 20 x 450 x 140 mm
KL 45 B





Rectangle console, 45 cm, matt black
(W x D x H): 20 x 450 x 140 mm
KL 45 Č MAT



Rectangle console, 45 cm, matt grey
(W x D x H): 30 x 450 x 140 mm
KL 45 S MAT



 Consoles be used as towel holders (except of the hidden ones *KONZOLE 40 SKR L* and *KONZOLE 40 SKR L*)

 Suitable for us with cabinets FORTY and DESK NEW



Faucets

Washbasin faucets

 Faucet, size M, which is higher, has also got a higher lever.

Faucet excl. waste outlet
OXO D 271M (height 156 mm)



OXO D 271 M

 Chrome finish

Faucet excl. waste outlet
OXO D 271 (height 130 mm)



OXO D 271

 Chrome finish

Tall faucet excl. waste outlet
OXO D 285 (height 310 mm)



OXO D 285

 Chrome finish

Tall faucet excl. waste outlet
OXO D 280 (height 316 mm)



OXO D 280

 Chrome finish

Concealed faucet OXO D 101
including the concealed valve



OXO D 101

 Chrome finish

Water waste outlets and siphons

Waste outlet OXO D VU799
5/4"



OXO D VU799

 Chrome finish

Washbasin siphon
OXO D US660 (adjustable width and height)



OXO D US660

 Polypropylene  Recommended siphon

Washbasin tap hole cover
ZASLEPKA UM
Diameter 50 mm



ZASLEPKA UM

 Chrome finish

Washbasin siphon
OXO D SU611



OXO D SU611

 Chrome finish



Electric equipment for drawers and side cabinets

A practical el. double-socket **POWERBOX** is suitable for charging sonic toothbrushes, etc. We also offer a portable LED lamp with sensor **LED OSVZAS**, which illuminates the interior of the furniture upon opening the doors or drawers. Very simple and fast mounting on a self-adhesive magnet. Charging via USB cable.

- ▶ You will appreciate the **POWERBOX** electric double-socket in the side cabinets, where allows you to charge your personal devices hidden out of the reach of children and no cables will obstruct your feet.
- ▶ In the event of a power outage, the **LED OSVZAS** serves as a practical flashlight.

Electric equipment for drawers and side cabinets

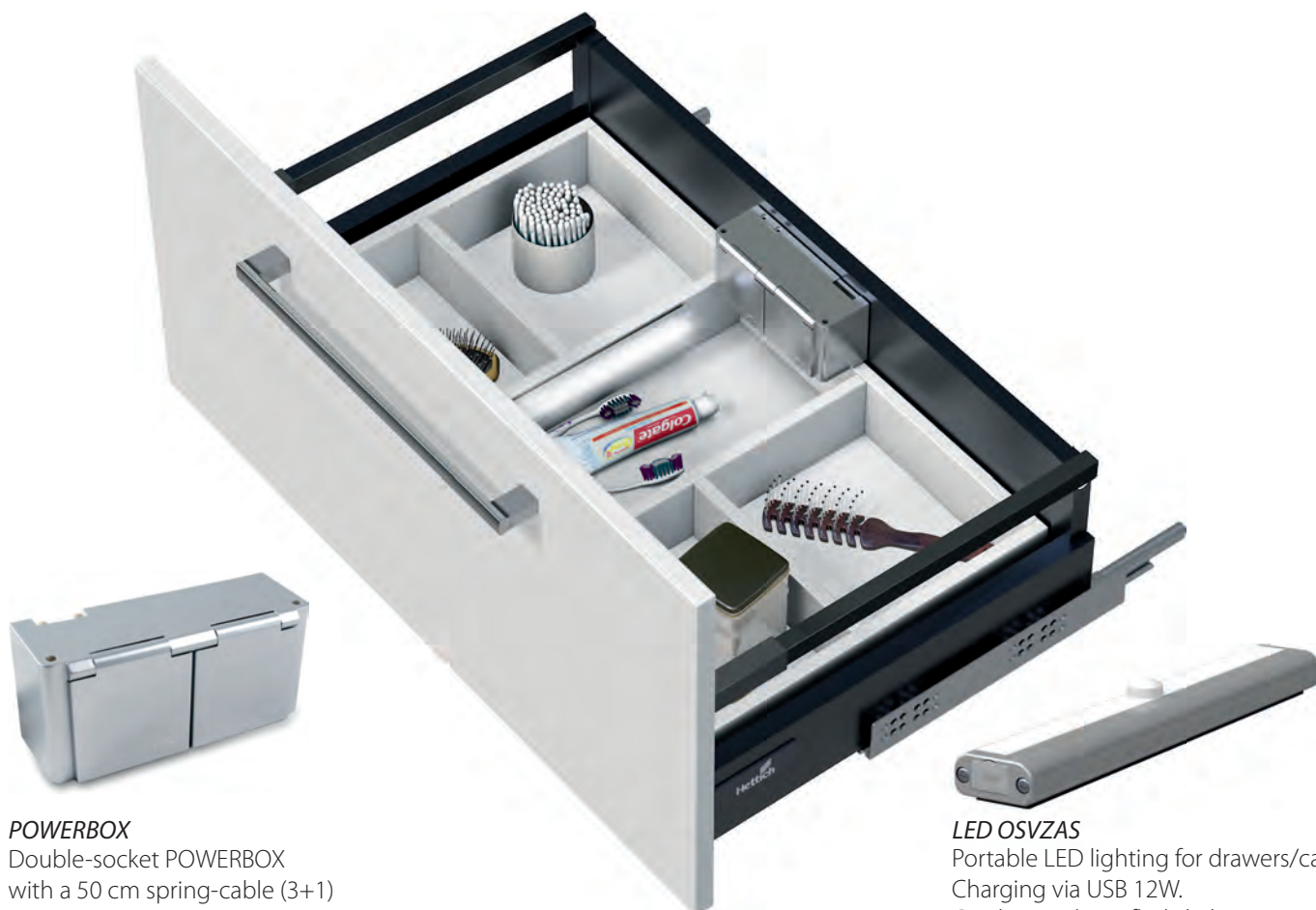

POWERBOX

Double-socket POWERBOX
with a 50 cm spring-cable (3+1)
250V AC IP 44
For charging el. toothbrush, etc.

LED OSVZAS

Portable LED lighting for drawers/cabinets.
Charging via USB 12W.
Can be used as a flash-light in case of
electric outage. Energy class G.



IP 44



INTEDOOR spol. s r.o.

Československé armády 348
471 54 Cvikov

GPS: 50°46'3.137"N, 14°37'31.193"E

Export department

Tel.: + 420 487 827 209

+ 420 487 827 222

Fax: + 420 487 827 203

E-mail: export@intedoor.cz

www.intedoor.cz/en