

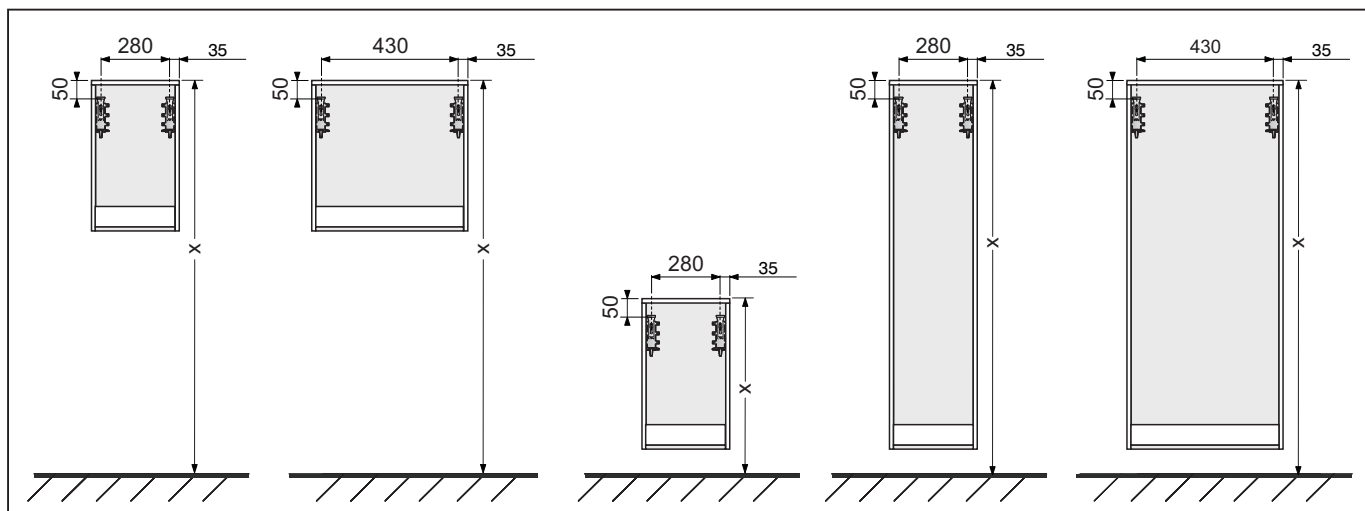

| | | |
|--|--|--|
| <p>! Před montáží zkontrolujte nosnost zdi. Před montáží zkontrolujte, zda je použitý upevňovací materiál vhodný pro daný typ zdi. V případě potřeby použijte jiný upevňovací materiál.</p> | <p>Vor der Montage die Tragfähigkeit der Wand prüfen. Vor der Montage prüfen, ob das mitgelieferte Befestigungsmaterial für den Wandtyp geeignet ist. Das Befestigungsmaterial bei Bedarf austauschen.</p> | <p>Before installation, check the bearing capacity of the wall. Before installation, check whether the fastening material supplied is suitable for the wall type. Use a different type of fastening material if necessary.</p> |
|--|--|--|

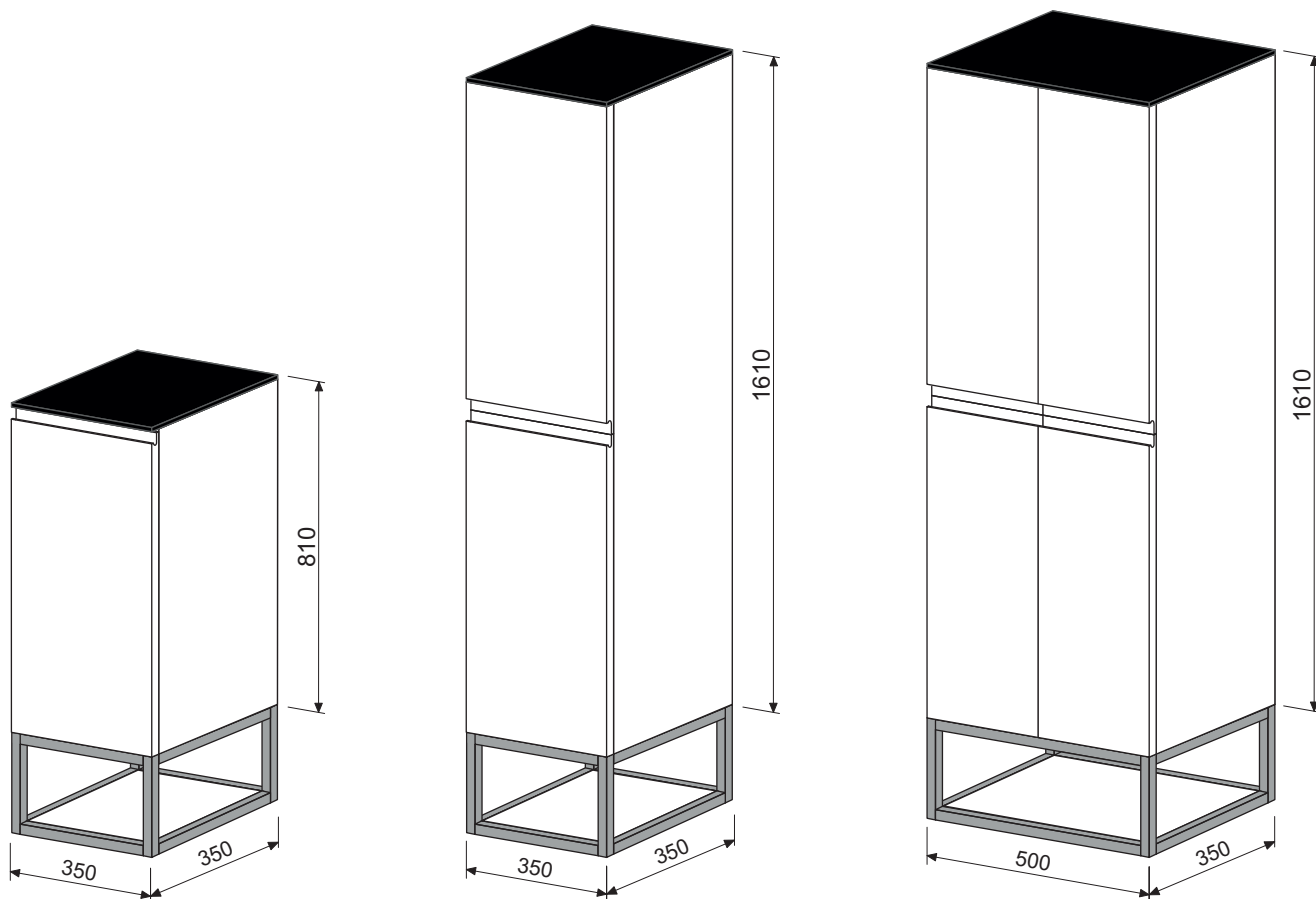



6

